

Nr. No. Code	Artikelnr. Article No. Code Article	Artikelbezeichnung Designation Désignation	Nr. No. Code	Artikelnr. Article No. Code Article	Artikelbezeichnung Designation Désignation
01	3.302 505 001	Trägerset Metall / Bracket set / Jeu des supports	06	3.306 615 001	Endstopfen für Fallrohr / End plug for drop tube / Embout pour tube de charge
02	3.306 005 000	Rollwelle / Roller tube / Tube d'enroulement	07	3.306 616 000	Klemmstück für Fallrohr / Grip für drop tube / Clip pour tube de charge
03	3.302 53x 000	Federantrieb / Springmechanism / Mécanisme à ressort	08	3.306 619 000	Griffflasche / Pull ring / Anse
04	3.302 516 001	Endstopfen / End plug / Embout			
05	3.306 100 000	Fallrohr / Drop tube / Tube de charge			

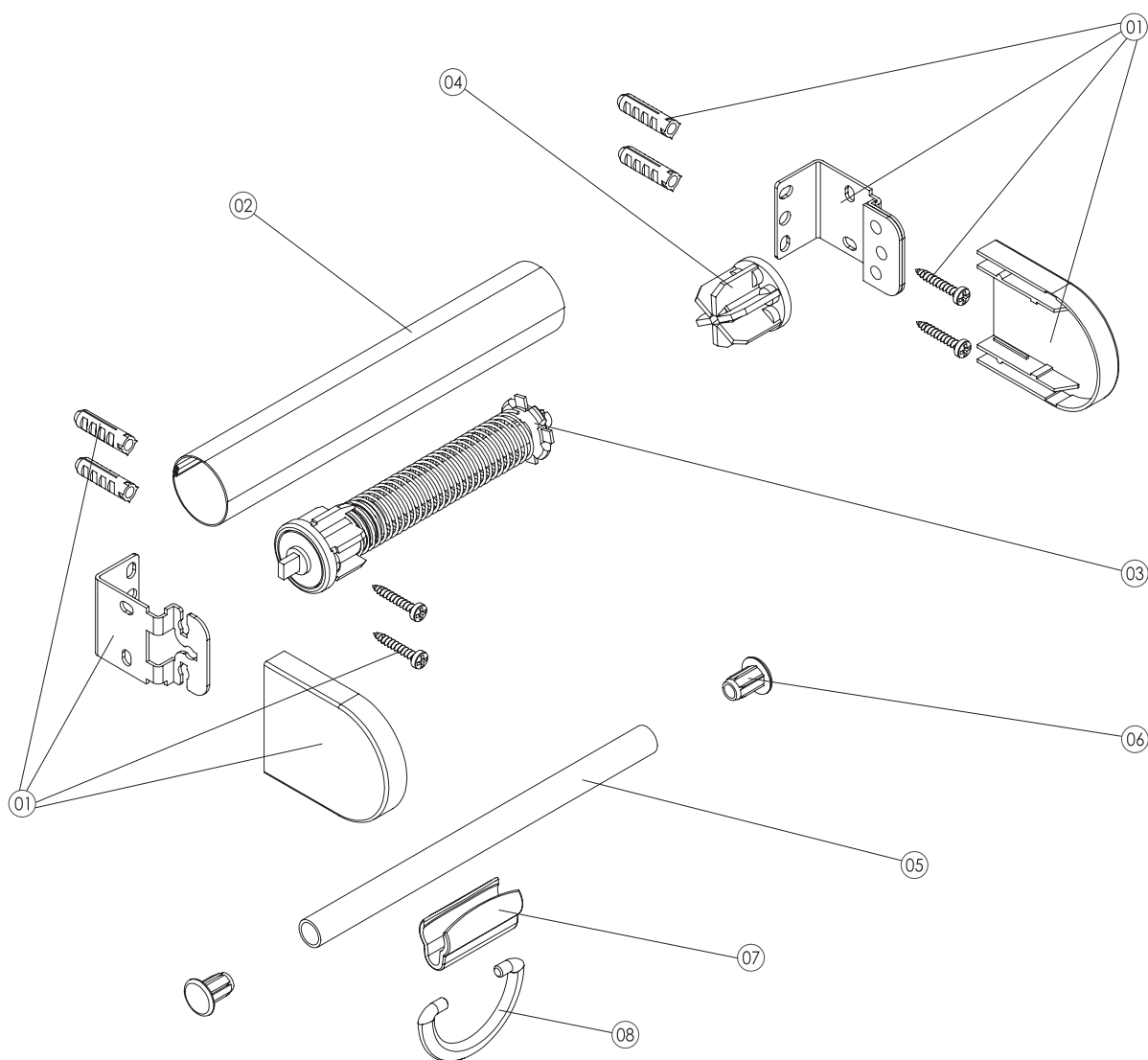

**MITTELZUG  
SPRING MECHANISM  
MANOEUVRE CENTRAL**

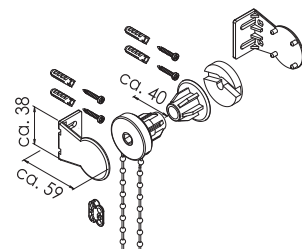
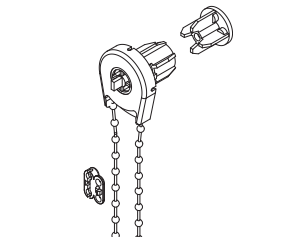
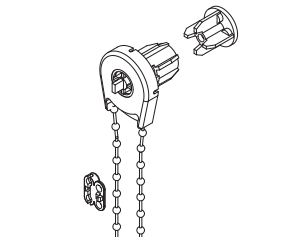
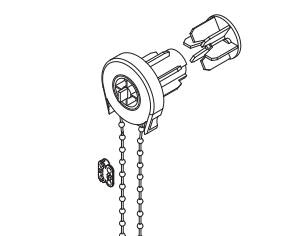
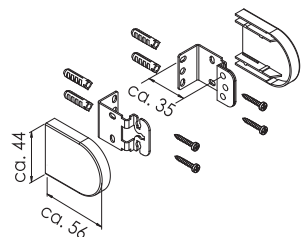
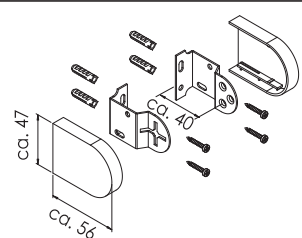
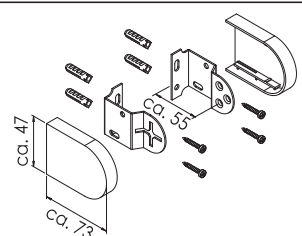
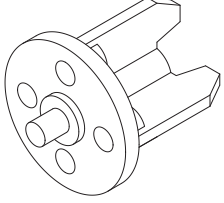
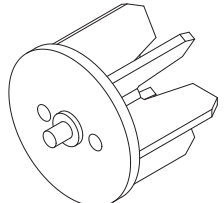

Abbildung Illustration Illustration	Artikelnr. Article No. Code Article	Artikelbezeichnung Designation Désignation	Packeinheit Packing Unit Conditionnement
	3.302 501  -001	D-100: SEITENZUGSET 25 mm, 1,25 m Kette 4,5x12 mm mit Kunststoffträgern (inkl. Schrauben und Dübel) D-100: SIDE WINDER SET 25 mm, 1,25 m ball chain loop 4,5x12 mm with plastic brackets (incl. screws and wall plugs) D-100: KIT MANŒUVRE LATÉRAL 25 mm, 1,25 m de chaînette 4,5x12 mm avec supports plastiques (incl. vis et chevilles)	250 Satz 250 sets 250 jeux
	3.302 502  -001	D-25: SEITENZUGSET 25 mm, 1,25 m Kette 4,5x12 mm, Kettenverbinder, Endstopfen D-25: SIDE WINDER SET 25 mm, 1,25 m ball chain loop 4,5x12 mm, ball chain connector, endplug D-25: KIT MANŒUVRE LATÉRAL 25 mm, 1,25 m de chaînette 4,5x12 mm, joint de chaînette, embout	250 Satz 250 sets 250 jeux
	3.302 503  -001	D-28: SEITENZUGSET 28 mm, 1,25 m Kette 4,5x12 mm, Kettenverbinder, Endstopfen D-28: SIDE WINDER SET 28 mm, 1,25 m ball chain loop 4,5x12 mm, ball chain connector, endplug D-28: KIT MANŒUVRE LATÉRAL 28 mm, 1,25 m de chaînette 4,5x12 mm, joint de chaînette, embout	250 Satz 250 sets 250 jeux
	3.302 504  -001	D-36: SEITENZUGSET 36 mm, 1,50 m Kette 4,5x12 mm, Kettenverbinder, Endstopfen D-36: SIDE WINDER SET 36 mm, 1,50 m ball chain loop 4,5x12 mm, ball chain connector, endplug D-36: KIT MANŒUVRE LATÉRAL 36 mm, 1,50 m de chaînette 4,5x12 mm, joint de chaînette, embout	100 Satz 100 sets 100 jeux
	3.302 505  -001 -058	D-25-B: METALL-TRÄGERSET (35 mm Wandabstand) 25/28 mm (inkl. Schrauben, Dübel und Abdeckkappen) D-25-B: METAL BRACKET-SET (35 mm wall distance) 25/28 mm (incl. screws, wall plugs and caps) D-25-B: KIT DE SUPPORTS, métal, 25/28 mm (35 mm distance du mur) (incl. vis, chevilles et capuchons)	250 Satz 250 sets 250 jeux
	3.302 506  -001	D-28-B: METALL-TRÄGERSET (40 mm Wandabstand) 25/28 mm (inkl. Schrauben, Dübel und Abdeckkappen) D-28-B: METAL BRACKET-SET (40 mm wall distance) 25/28 mm (incl. screws, wall plugs and caps) D-28-B: KIT DE SUPPORTS, métal, 25/28 mm (40 mm distance du mur) (incl. vis, chevilles et capuchons)	250 Satz 250 sets 250 jeux
	3.302 507  -001 -058	D-36-B: METALL-TRÄGERSET (55 mm Wandabstand) 36 mm (inkl. Schrauben, Dübel und Abdeckkappen) D-36-B: METAL BRACKET-SET (55 mm wall distance) 36 mm (incl. screws, wall plugs and caps) D-36-B: KIT DE SUPPORTS, métal, (55 mm distance du mur) 36 mm (incl. vis, chevilles et capuchons)	100 Satz 100 sets 100 jeux

Abbildung Illustration Illustration	Artikelnr. Article No. Code Article	Artikelbezeichnung Designation Désignation	Packeinheit Packing Unit Conditionnement
	3.302 516	ENDSTOPFEN 25 mm (D-25), mit Stahlpin ENDPLUG 25 mm (D-25), with steel pin EMBOUT 25 mm (D-25), avec pin acier	100 Stck 100 pcs 100 pcs
	-001	weiß / white / blanc	
	3.302 548 001	ENDSTOPFEN 25 mm, mit Stahlpin, gefedert, weiss ENDPLUG 25 mm, with steel pin, spring loaded, white EMBOUT 25 mm, avec goupille acier, sur ressort, blanc	100 Stck 100 pcs 100 pcs
	3.302 517	ENDSTOPFEN 28 mm (D-28), mit Stahlpin ENDPLUG 28 mm (D-28), with steel pin EMBOUT 28 mm (D-28), avec pin acier	100 Stck 100 pcs 100 pcs
	-001	weiß / white / blanc	
	3.302 518	ENDSTOPFEN 36 mm (D-36), mit Stahlpin ENDPLUG 36 mm (D-36), with steel pin EMBOUT 36 mm (D-36), avec goupille acier	100 Stck 100 pcs 100 pcs
	-001	weiß / white / blanc	