

RAFFROLLO/ROMAN BLIND/STORE BATEAU

Abbildung Illustration Illustration	Artikelbezeichnung Designation Désignation	S-163	S-160
	GETRIEBE LINKS SIDEWINDER LEFT MÉCANISME À CHÂINETTE, GAUCHE	●	●
	GETRIEBE RECHTS SIDEWINDER RIGHT MÉCANISME À CHAINETTE, DROITE	●	●
	ÜBERSETZUNG 1:1 TRANSMISSION 1:1 TRANSMISSION 1:1	●	●
	ÜBERSETZUNG 1:2 TRANSMISSION 1:2 TRANSMISSION 1:2	●	●
	GETRIEBE SEMIAUTOMATIK SIDEWINDER SEMIAUTOMATIC MÉCANISME À CHAINETTE SEMI-AUTOMATIQUE		●

Nr. No. Code	Artikelnr. Article No. Code Article	Artikelbezeichnung Designation Designation	Nr. No. Code	Artikelnr. Article No. Code Article	Artikelbezeichnung Designation Designation
01	3.109 727 001	Kopfprofil / Head rail / Boîtier haut	06	3.109 711 000	Schnurbefestigungshaken / Hook for cord / Crochet pour cordon
02	3.109 728 000	Wendeachse / Tilt shaft / Axe d'orientation	07	3.109 732 000	Flauschband / Velcro / Velcro
03	3.109 739 301	Seitenzuggetriebe / Sidewinder mechanism / Mécanisme à chaînette	08	3.306 107 001	Beschwerungsleiste / Bottom rail / Boîtier de lestage
04	3.109 730 201	Endkappe für Kopfprofil / Endcap for head rail / Embout boîtier haut	09	3.109 769 001	Montageclip / Fixing clip / Clip de montage
05	3.109 731 000	Wickelkonus / Cone / Cône enrouleur	10	3.232.137.000	Sicherheitskettenhalter / Safety Chainholder / Support de chaîne de sécurité

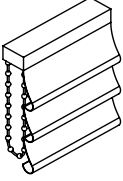
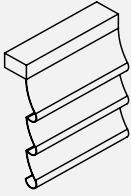
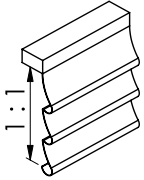
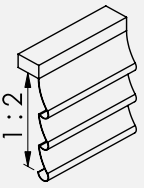
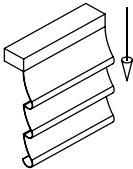
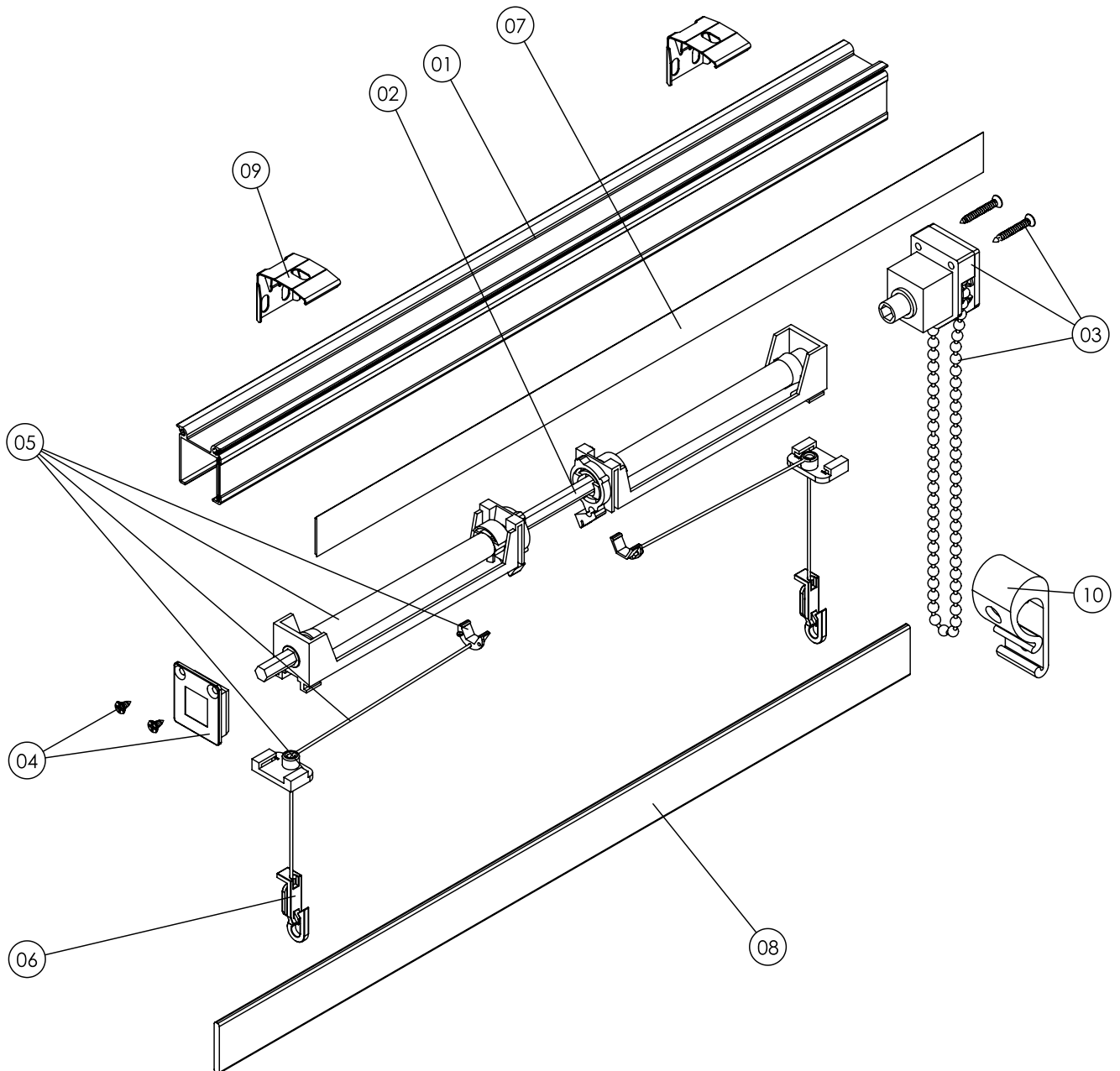

S-SERIE RAFF S-163

S-SERIES ROMAN BLIND S-163

S-SÉRIE SYSTÈME STORE BATEAU S-163

Nr. No. Code	Artikelnr. Article No. Code Article	Artikelbezeichnung Designation Designation	Nr. No. Code	Artikelnr. Article No. Code Article	Artikelbezeichnung Designation Designation
01	3.109 727 001	Kopfprofil / Head rail / Boîtier haut	06	3.109 731 000	Wickelkonus / Cone / Cône enrouleur
02	3.109 728 000	Wendeachse / Tilt shaft / Axe d'orientation	07	3.109 711 000	Schnurbefestigungshaken / Hook for cord / Crochet pour cordon
03	3.109 734 301	Seitenzuggetriebe / Sidewinder mechanism / Mécanisme à chaînette	08	3.109 732 000	Flauschband / Velcro / Velcro
04	3.109 730 201	Endkappe für Kopfprofil / Endcap for head rail / Embout boîtier haut	09	3.109 767 001	Beschwerungsleiste / Bottom rail / Boîtier de lestage
05	3.109 738 000	Speedreducer / Speedreducer / Réducteur de vitesse	10	3.109 766 000	Beschwerungsstück / Balance weight / Pièce de lestage
			11	3.109 733 001	Montageträger / Bracket / Support

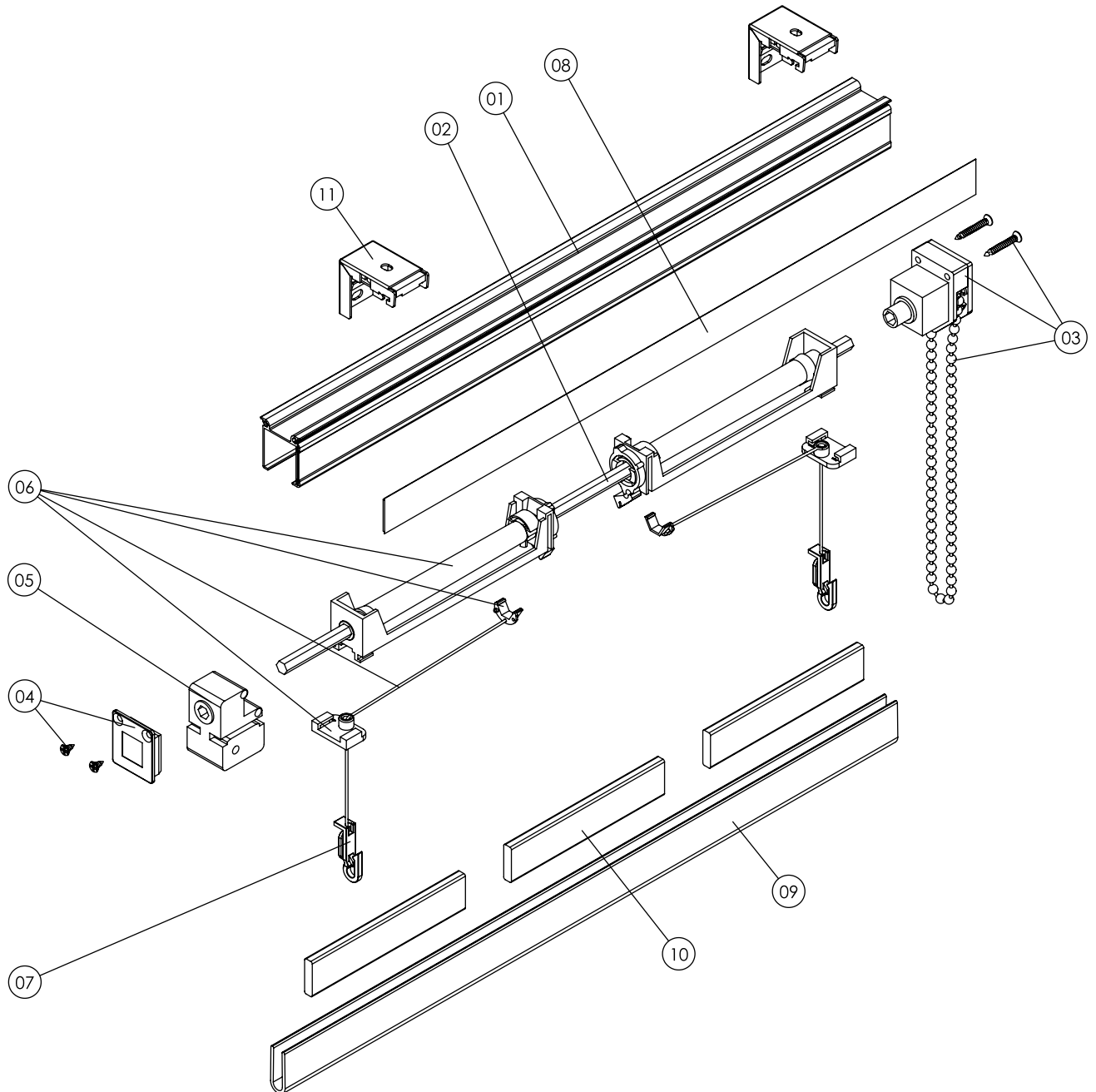
**S-SERIE RAFF S-160**

S-SERIES ROMAN BLIND S-160

S-SÉRIE SYSTÈME STORE BATEAU S-160

Abbildung Illustration Illustration	Artikelnr. Article No. Code Article	Artikelbezeichnung Designation Designation	Packeinheit Packing Unit Conditionnement
	3.109.727	KOPFPROFIL (inkl. Klettband) HEAD RAIL (incl. Velcro) BOÎTIER HAUT (incl. Velcro)	60 m 60 m 60 m
	-001	weiß / white / blanc	Längen à 6 m lengths of 6 m longueurs de 6 m
	3.109.728.000	WENDEACHSE, Aluminium, 6 mm, sechskant TILT SHAFT, aluminium, 6 mm, hexagon AXE D'ORIENTATION, aluminium, 6 mm hexagonal	60 m 60 m 60 m
			Längen à 6 m lengths of 6 m longueurs de 6 m
	3.306.107	BESCHWERUNGSLEISTE, Aluminium (ca. 200 g/m) BOTTOM RAIL, aluminium (ca. 200 g/m) BOÎTIER DE LESTAGE, aluminium (ca. 200 g/m)	60 m 60 m 60 m
	-001	weiß / white / blanc	Längen à 6 m lengths of 6 m longueurs de 6 m
	3.109.767	KUNSTSTOFF-KLEMMLEISTE (für Stahl-Beschwerung) CLAMPING PROFILE, plastic LISTEAU DE SERRAGE, en plastique	30 m 30 m 30 m
	-001	weiß / white / blanc	Längen à 3 m lengths of 3 m longueurs de 3 m
	3.109.766.000	STAHL-BESCHWERUNG (ca. 24 cm) BALANCE WEIGHT (app. 24 cm) PIÈCE DE LESTAGE (24 cm)	100 Stck 100 pcs 100 pcs
	3.109.730.201	ENDKAPPE für Kopfprofil, inkl. Schrauben END CAP for head rail, incl. screws EMBOUT boîtier haut, vis incl.	100 Stck 100 pcs 100 pcs

Abbildung Illustration Illustration	Artikelnr. Article No. Code Article	Artikelbezeichnung Designation Designation	Packeinheit Packing Unit Conditionnement
---	---	--	--



	3.109.734.301	GETRIEBE SEMIAUTOMATIK S 160, rechts (1:1), mit Kette (1,25 m) SIDEWINDER SEMI-AUTOMATIC S 160, right (1:1) with chain (1,25 m) MÉCANISME À CHAÎNETTE SEMI-AUTOMATIQUE S 160, droite (1:1) avec chaînette (1,25 m)	100 Stck 100 pcs 100 pcs
	3.109.735.301	GETRIEBE SEMIAUTOMATIK S 160, links (1:1), mit Kette (1,25 m) SIDEWINDER SEMI-AUTOMATIC S 160, left (1:1) with chain (1,25 m) MÉCANISME À CHAÎNETTE SEMI-AUTOMATIQUE S 160, gauche (1:1) avec chaînette (1,25 m)	100 Stck 100 pcs 100 pcs
	3.109.734.201	GETRIEBE SEMIAUTOMATIK S 160, rechts (1:1), ohne Kette SIDEWINDER SEMI-AUTOMATIC S 160, right (1:1) without chain MÉCANISME À CHAÎNETTE SEMI-AUTOMATIQUE S 160, droite (1:1) sans chaînette	100 Stck 100 pcs 100 pcs
	3.109.735.201	GETRIEBE SEMIAUTOMATIK S 160, links (1:1), ohne Kette SIDEWINDER SEMI-AUTOMATIC S 160, left (1:1) without chain MÉCANISME À CHAÎNETTE SEMI-AUTOMATIQUE S 160, gauche (1:1) sans chaînette	100 Stck 100 pcs 100 pcs

Getriebe auch für Metallketten geeignet / Sidewinder also suitable with metal chains / Mécanisme à chaînette utilisable pour chaînes métalliques également

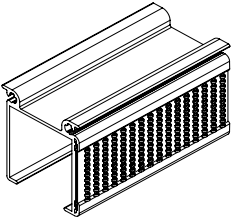
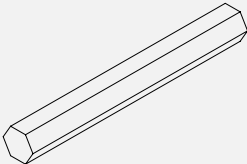
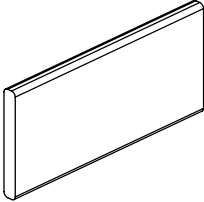
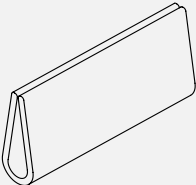
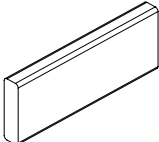
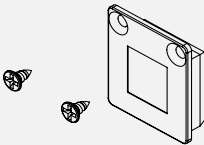
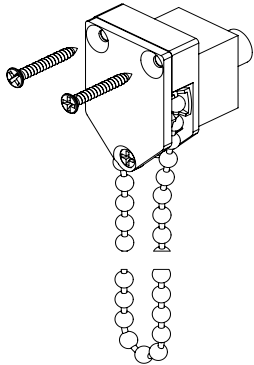
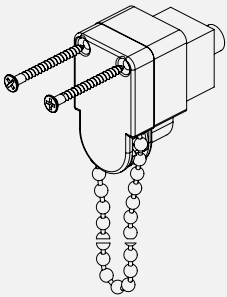

	3.109.736.301	GETRIEBE SEMIAUTOMATIK S 160, rechts (1:2), mit Kette (1,25 m) SIDEWINDER SEMI-AUTOMATIC S 160, right (1:2) with chain (1,25 m) MÉCANISME À CHAÎNETTE SEMI-AUTOMATIQUE S 160, droite (1:2) avec chaînette (1,25 m)	100 Stck 100 pcs 100 pcs
	3.109.737.301	GETRIEBE SEMIAUTOMATIK S 160, links (1:2), mit Kette (1,25 m) SIDEWINDER SEMI-AUTOMATIC S 160, left (1:2) with chain (1,25 m) MÉCANISME À CHAÎNETTE SEMI-AUTOMATIQUE S 160, gauche (1:2) avec chaînette (1,25 m)	100 Stck 100 pcs 100 pcs
	3.109.736.201	GETRIEBE SEMIAUTOMATIK S 160, rechts (1:2), ohne Kette SIDEWINDER SEMI-AUTOMATIC S 160, right (1:2) without chain MÉCANISME À CHAÎNETTE SEMI-AUTOMATIQUE S 160, droite (1:2) sans chaînette	100 Stck 100 pcs 100 pcs
	3.109.737.201	GETRIEBE SEMIAUTOMATIK S 160, links (1:2), ohne Kette SIDEWINDER SEMI-AUTOMATIC S 160, left (1:2) without chain MÉCANISME À CHAÎNETTE SEMI-AUTOMATIQUE S 160, gauche (1:2) sans chaînette	100 Stck 100 pcs 100 pcs

Getriebe auch für Metallketten geeignet / Sidewinder also suitable with metal chains / Mécanisme à chaînette utilisable pour chaînes métalliques également

Abbildung Illustration Illustration	Artikelnr. Article No. Code Article	Artikelbezeichnung Designation Designation	Packeinheit Packing Unit Conditionnement
	3.109.739.301	GETRIEBE STANDARD S 163 (1:1) mit Kette (125 cm) SIDE WINDER STANDARD FOR S-163 (transmission 1:1) with 125 cm endless ball chain MÉCANISME À CHAÎNETTE STANDARD pour S-163 (transmission 1:1) avec chaînette 125 cm	100 Stck 100 pcs 100 pcs
	3.109.739.201	GETRIEBE STANDARD S 163 (1:1) ohne Kette SIDE WINDER FOR STANDARD S-163 (transmission 1:1) without chain MÉCANISME À CHAÎNETTE STANDARD pour S-163 (transmission 1:1) sans chaînette	100 Stck 100 pcs 100 pcs
Getriebe auch für Metallketten geeignet / Sidewinder also suitable with metal chains / Mécanisme à chaînette utilisable pour chaînes métalliques également			
	3.109.740.301	GETRIEBE STANDARD S 163 (1:2) mit Kette (125 cm) SIDE WINDER STANDARD FOR S-163 (transmission 1:2) with 125 cm endless ball chain MÉCANISME À CHAÎNETTE STANDARD pour S-163 (transmission 1:2) avec chaînette 125 cm	100 Stck 100 pcs 100 pcs
	3.109.740.204	GETRIEBE STANDARD S 163 (1:2) ohne Kette SIDE WINDER STANDARD FOR S-163 (transmission 1:2) without chain MÉCANISME À CHAÎNETTE STANDARD pour S-163 (transmission 1:2) sans chaînette	100 Stck 100 pcs 100 pcs
Getriebe auch für Metallketten geeignet / Sidewinder also suitable with metal chains / Mécanisme à chaînette utilisable pour chaînes métalliques également			
	3.109.738.000	SPEED REDUCER für SemiAutomatik (400-3.000 g) SPEED REDUCER for Semi-Automatic (400-3.000 g) REDUCTEUR DE VITESSE pour Semi-Automatique (400-3.000 g)	100 Stck 100 pcs 100 pcs
	3.109.731.000	WICKELKONUS für Raff-Rollo mit Schnur 3,3 m WIND UP CONE for roman blind, with cord 3,3 m CÔNE ENROULEUR pour store bateau avec cordon 3,3 m	200 Stck 200 pcs 200 pcs
	3.109.733	MONTAGETRÄGER (mit Feder) BRACKET with spring SUPPORT avec ressort	100 Stck 100 pcs 100 pcs
	-001	vernickelt / nickel-plated / nickelé	
	-101	weiß / white / blanc	
	3.109.769	MONTAGECLIP für Kopfprofil 3.109 727 FIXING CLIP for head rail 3.109 727 CLIP DE MONTAGE pour boîtier haut 3.109 727	100 Stck 100 pcs 100 pcs
	-000	vernickelt / nickel-plated / nickelé	
	-001	weiß / white / blanc	

Abbildung Illustration Illustration	Artikelnr. Article No. Code Article	Artikelbezeichnung Designation Designation	Packeinheit Packing Unit Conditionnement
---	---	--	--



3.109.711.000	SCHNURBEFESTIGUNGSHAKEN HOOK for cord CROCHET pour fixer cordon	500 Stck 500 pcs 500 pcs
---------------	---	--------------------------------

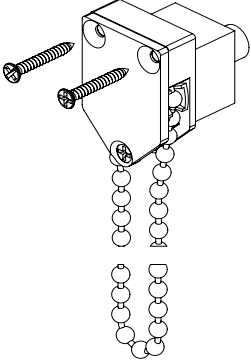
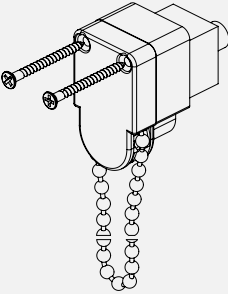
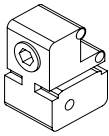
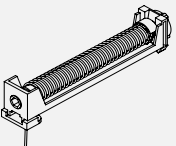
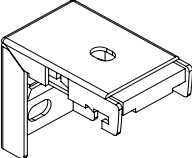
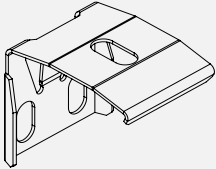
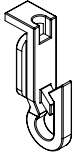
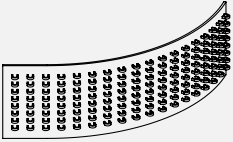

3.333.217	FLAUSCHBAND, 20 mm, zum Aufnähen BRUSHED TAPE, 20 mm, for sewing on fabric RUBAN-VELOURS VELCRO, 20 mm, à coudre sur tissu	1 Rolle à 30 m 1 roll of 30 m 1 bobine à 30 m
-----------	--	---

-001 weiß / white / blanc

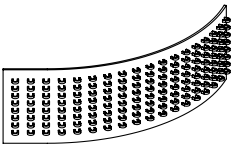

3.333.216	FLAUSCHBAND, 20 mm, selbstklebend BRUSHED TAPE, 20 mm, selfadhesive RUBAN-VELOURS VELCRO, 20 mm, autocollant	1 Rolle à 30 m 1 roll of 30 m 1 bobine à 30 m
-----------	--	---

-001 weiß / white / blanc

Nr. No. Code	Artikelnr. Article No. Code Article	Artikelbezeichnung Designation Designation	Nr. No. Code	Artikelnr. Article No. Code Article	Artikelbezeichnung Designation Designation
01	3.180.703.001	Klebeleiste / Sticking profile / Profilé adhésif	04	3.180.620.001	Schieber / Pusher / Curseur
02	3.180.610.001	Endkappe / End cap / Capuchon	05	3.180.640.001	Fiberglas-Stab / Fiberglass Rod / Barre en fibre
03	3.180.630.001	Gleiter / Slider / Glissière			

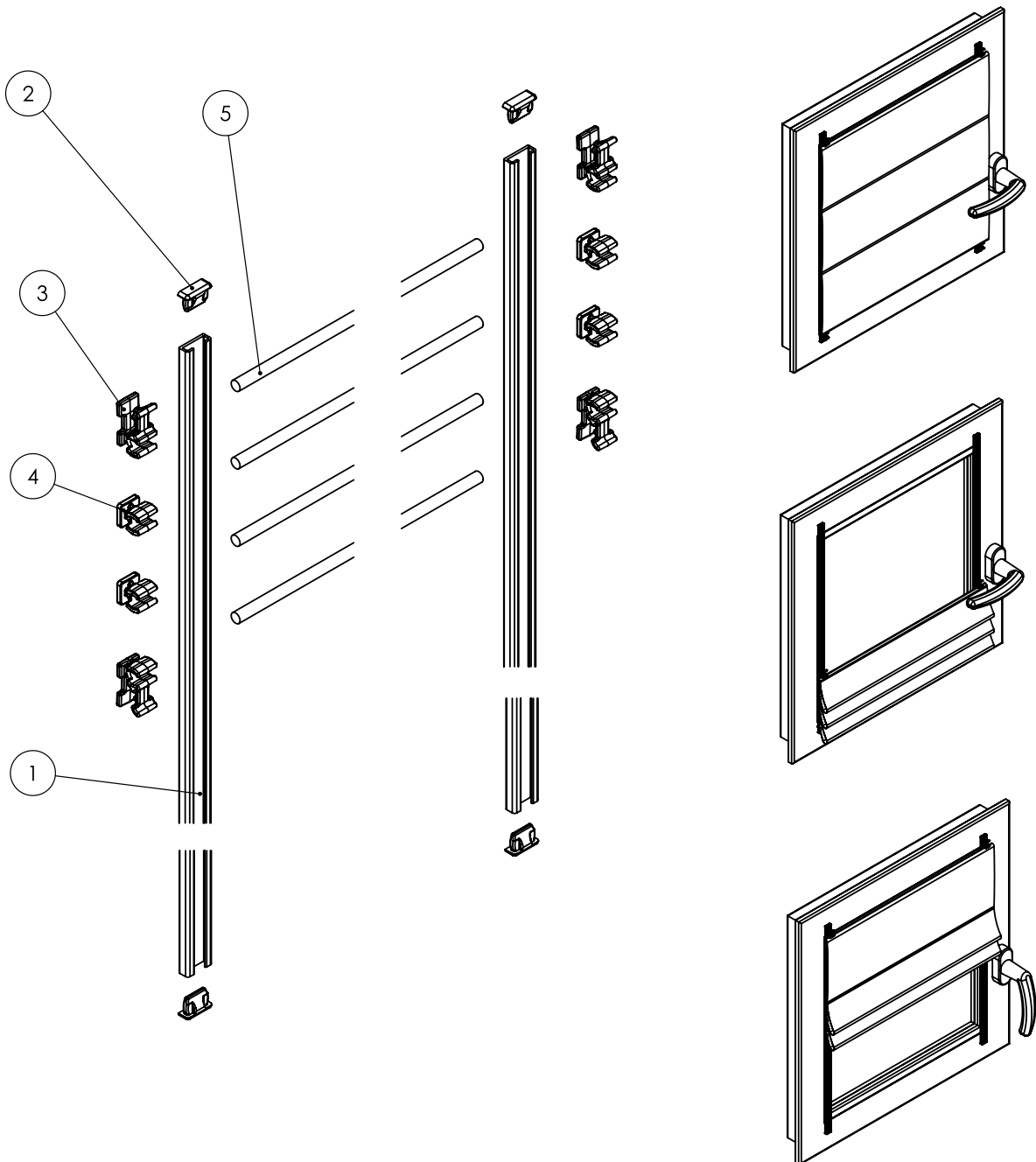

VERSCHIEBBARER RAFFBEHANG

SLIDING ROMAN BLIND

STORE BATEAU MOBILE

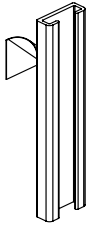
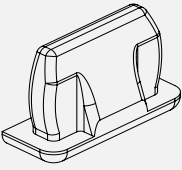
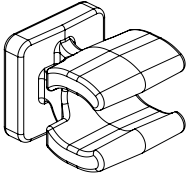
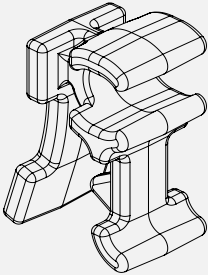
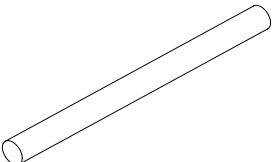
Abbildung Illustration Illustration	Artikelnr. Article No. Code Article	Artikelbezeichnung Designation Designation	Packeinheit Packing Unit Conditionnement
	3.180.703	KLEBELEISTE für verschiebbaren Raffbehang, weiß, Längen a. 2,7 m STICKING PROFILE for Sliding Roman Blind, white, lengths of 2,7 m QUICKFIT-PROFILÉ Adhésif , blanc, longueurs de 2,7 m	86,4 m 86,4 m 86,4 m
	-001	weiß / white / blanc	
	-058	eloxiert / anodized / anodize	
	3.180.610	ENDKAPPE für verschiebbaren Raffbehang END CAP for Sliding Roman Blind CAPUCHON pour Quickfit-Profilé Adhésif	100 Stck 100 pcs 100 pcs
	-001	weiß / white / blanc	
	-011	grau / grey / gris	
	3.180.620	GLEITER für verschiebbaren Raffbehang SLIDER for Sliding Roman Blind GLISSIÈRE pour Quickfit-Profilé Adhésif	100 Stck 100 pcs 100 pcs
	-001	weiß / white / blanc	
	-011	grau / grey / gris	
	3.180.630	SCHIEBER für verschiebbaren Raffbehang PUSHER for Sliding Roman Blind CURSEUR à glissière	100 Stck 100 pcs 100 pcs
	-001	weiß / white / blanc	
	-011	grau / grey / gris	
	3.180.631	FIBERGLAS-STAB für verschiebbaren Raffbehang FIBERGLASS ROD for Sliding Roman Blind BARRE EN FIBRE de verre pour Profilé Adhésif	100 m 100 m 100 m
	-001	weiß / white / blanc	