

Abbildung Illustration Illustration	Artikelnr. Article No. Code Article	Artikelbezeichnung Designation Désignation	Packeinheit Packing Unit Conditionnement
	3.233 770 -001 -058	COMPACT-LAUFSCHIENE, 44,5x25 mm, Aluminium COMPACT-HEADRAIL, 44.5x25 mm, aluminium BOÎTIER COMPACT, 44,5x25 mm, aluminium weiß / white / blanc eloxiert / anodized / anodisé	Längen à 7 m lengths of 7 m longueurs de 7 m 70 m 70 m
	3.233 870 -001 -049 -058	OMEGA-LAUFSCHIENE, 44,5x25 mm, Aluminium OMEGA-HEADRAIL, 44.5x25 mm, aluminium BOÎTIER-OMEGA, 44,5x25 mm, aluminium weiß / white / blanc schwarz / black / noir eloxiert / anodized / anodisé	Längen à 7 m lengths of 7 m longueurs de 7 m 70 m 70 m 70 m
	3.233 775 -001	EINBAUPROFIL für Systemdecken INSTALLATION-PROFILE for suspended ceilings PROFILÉ À ENCASTRER pour plafonds suspendus weiß / white / blanc	Längen à 7 m lengths of 7 m longueurs de 7 m 56 m
	3.233 776 -001	CLIP zur Montage der Laufschiene im Einbauprofil, Kunststoff CLIP for fixing the headrail to the installation profile, plastic CLIP pour montage du rail dans profilé à encastrer, plastique weiß / white / blanc	50 Stck 50 pcs 50 pcs
	3.233 777 000	MONTAGESET FÜR EINBAUPROFIL MOUNTING SET FOR INSTALLATION PROFILE KIT DE MONTAGE POUR PROFILÉ À ENCASTRER	50 Satz 50 sets 50 jeux
	3.233 671 000	WENDEACHSE, Aluminium, 6 mm, 3 Kant TILT SHAFT, aluminium, 6 mm, 3 edged AXE D'ORIENTATION, aluminium, 6 mm, 3 pans Längen à 7 m / lengths of 7 m / longueurs de 7 m	70 m 70 m 70 m

Abbildung Illustration Illustration	Artikelnr. Article No. Code Article	Artikelbezeichnung Designation Désignation	Packeinheit Packing Unit Conditionnement
	3.233 670 000	WENDEACHSE, Aluminium, 6 mm, 4 Kant TILT SHAFT, aluminium, 6 mm, 4 edged AXE D'ORIENTATION, aluminium, 6 mm, 4 pans Längen à 7 m / lengths of 7 m / longueurs de 7 m	70 m 70 m 70 m
	3.234 135 000	LAUFWAGEN (9 mm) MIT AUSWECHSELBAREM TRANSPARENTEN KUNSTSTOFFHAKEN für Metallabstandshalter, verwendbar mit 3 und 4kant-Wendeachse RUNNER (9 mm) WITH CHANGEABLE TRANSPARENT PLASTIC HOOK for metal links and for 3 and 4 edged shafts CHARIOT (9 mm) AVEC CROCHET TRANSPARENT, ÉCHANGEABLE, pour écarteur métal et axes d'orientation à 3 et 4 pans	2.000 Stck 2.000 pcs 2.000 pcs
	3.234 136 000	LAUFWAGEN (9 mm) MIT AUSWECHSELBAREM TRANSPARENTEN KUNSTSTOFFHAKEN für Kunststoffabstandshalter, verwendbar mit 3 und 4kant-Wendeachse RUNNER (9 mm) WITH CHANGEABLE TRANSPARENT PLASTIC HOOK for plastic links and for 3 and 4 edged shafts CHARIOT (9 mm) AVEC CROCHET TRANSPARENT, ÉCHANGEABLE, pour écarteur plastique et axes d'orientation à 3 et 4 pans	2.000 Stck 2.000 pcs 2.000 pcs
	3.234 137 -000	HAKEN FÜR LAUFWAGEN HOOK FOR RUNNER CROCHET POUR CHARIOT transparent / transparent / transparent	100 Stck 100 pcs 100 pcs
	3.233 -305 000 -306 000	SLOPE-HAKEN, transparent, mit Kardangelen für Laufwagen 3.234 136 000 und 3.234 140 000 (transparent) SLOPE HOOK, transparent, with cardan joint for runner 3.234 136 000 and 3.234 140 000 (transparent) CROCHET SLOPE, transparent, avec joint de cardan pour chariot 3.234 136 000 et 3.234 140 000 (transparent) kurz / short / court 35° lang / long / long 55°	100 Stck 100 pcs 100 pcs

Abbildung Illustration Illustration	Artikelnr. Article No. Code Article	Artikelbezeichnung Designation Désignation	Packeinheit Packing Unit Conditionnement
	3.234	LAUFWAGENZUG, bestehend aus 100 Laufwagen 3.234 136 000 und Kunststoffabstandshaltern 3.233 229 XXX RUNNER TRACK, including 100 runners 3.234 136 000 and plastic spacer links 3.233 229 XXX TRAIN DE CHARIOTS, comprenant 100 chariots 3.234 136 000 et écarteurs en plastique 3.233 229 XXX	10 Stck 10 pcs 10 pcs
	-143 073 -144 074	rechts 73 mm / right 73 mm / droite 73 mm links 73 mm / left 73 mm / gauche 73 mm	
	-143 075 -144 075	rechts 75 mm / right 75 mm / droite 75 mm links 75 mm / left 75 mm / gauche 75 mm	
	-143 078 -144 078	rechts 78 mm / right 78 mm / droite 78 mm links 78 mm / left 78 mm / gauche 78 mm	
	-143 080 -144 080	rechts 80 mm / right 80 mm / droite 80 mm links 80 mm / left 80 mm / gauche 80 mm	
	-143 106 -144 106	rechts 106 mm / right 106 mm / droite 106 mm links 106 mm / left 106 mm / gauche 106 mm	
	-143 110 -144 110	rechts 110 mm / right 110 mm / droite 110 mm links 110 mm / left 110 mm / gauche 110 mm	
	-143 114 -144 114	rechts 114 mm / right 114 mm / droite 114 mm links 114 mm / left 114 mm / gauche 114 mm	
	-143 117 -144 117	rechts 117 mm / right 117 mm / droite 117 mm links 117 mm / left 117 mm / gauche 117 mm	
		3.234	SCHNURZUGWAGEN mit Klemmstück und Schraube für Laufwagen 3.234 136 000 und 3.234 135 000 CORD DRIVE RUNNER with clip and screw for carrier 3.234 136 000 and 3.234 135 000 CHARIOT DE TIRAGE DU CORDON avec clip et vis pour chariot 3.234 136 000 et 3.234 135 000
-138 000 -139 000		rechts / right / droite links / left / gauche	
	3.233	MAGNETHALTER für Schnurzugwagen 3.234 138 000 und 3.234 139 000 MAGNET HOLDER for cord drive runner 3.234 138 000 and 3.234 139 000 SUPPORT MAGNÉTIQUE pour chariot de tirage du cordon 3.234 138 000 et 3.234 139 000	100 Stck 100 pcs 100 pcs
	-209 001 -210 000	rechts-weiß / right-white / droite-blanc links-natur / left-natural / gauche-naturel	
	3.233 207	MAGNETWELLENSTÜTZE für Laufwagen 3.234 136 000 und 3.234 135 000 MAGNET SHAFT SUPPORT for carrier 3.234 136 000 and 3.234 135 000 SUPPORT D'ARBRE MAGNÉTIQUE pour chariot 3.234 136 000 et 3.234 135 000	100 Stck 100 pcs 100 pcs
	-001	rechts-weiß / right-white / droite-blanc	

Abbildung Illustration Illustration	Artikelnr. Article No. Code Article	Artikelbezeichnung Designation Désignation	Packeinheit Packing Unit Conditionnement
	3.233 208 -000	MAGNETWELLENSTÜTZE für Laufwagen 3.234 136 000 und 3.234 135 000 MAGNET SHAFT SUPPORT for carrier 3.234 136 000 and 3.234 135 000 SUPPORT D'ARBRE MAGNÉTIQUE pour chariot 3.234 136 000 et 3.234 135 000 links-natur / left-natural / gauche-naturel	100 Stck 100 pcs 100 pcs
	3.233 244 000	MITTELSTÜTZE, universal CENTRE SUPPORT, universal SUPPORT CENTRAL, universel	100 Stck 100 pcs 100 pcs
	3.234 134 000	SCHLEPPHAKEN TOW HOOK CROCHET DE TIRAGE	100 Stck 100 pcs 100 pcs
	3.233 307 000	SLOPE WELLENSTÜTZE für Laufwagen 3.234 136 000, 3.234 135 000 und 3.234 140 000 SLOPE SHAFT SUPPORT for carrier 3.234 136 000, 3.234 135 000 and 3.234 140 000 SUPPORT D'ARBRE SLOPE pour chariot 3.234 136 000, 3.234 135 000 et 3.234 140 000	100 Stck 100 pcs 100 pcs
	3.233 229 -073 -075 -078 -080 -106 -110 -114 -117	ABSTANDSHALTER, Kunststoff, für Laufwagen 3.234 136 000 LINK SPACER, plastic, for runner 3.234 136 000 ÉCARTEUR, plastique, pour chariot 3.234 136 000 73 mm Länge / length / longueur 75 mm Länge / length / longueur 78 mm Länge / length / longueur 80 mm Länge / length / longueur 106 mm Länge / length / longueur 110 mm Länge / length / longueur 114 mm Länge / length / longueur 117 mm Länge / length / longueur	1.000 Stck 1.000 pcs 1.000 pcs

Abbildung Illustration Illustration	Artikelnr. Article No. Code Article	Artikelbezeichnung Designation Désignation	Packeinheit Packing Unit Conditionnement
	3.234 156	ABSTANDSHALTER EDELSTAHL, 0,22 x 8 mm für Laufwagen 3.234 135 000, 3.234 150 000, 3.230 184 000 LINK SPACER FINE STEEL, 0,22 x 8 mm for runner 3.234 135 000, 3.234 150 000, 3.230 184 000 ÉCARTEUR ACIER INOXYDABLE, 0,22 x 8 mm pour chariot 3.234 135 000, 3.234 150 000, 3.230 184 000	1.000 Stck 1.000 pcs 1.000 pcs
	-070	70 mm Länge / length / longueur	
	-071	71 mm Länge / length / longueur	
	-072	72 mm Länge / length / longueur	
	-073	73 mm Länge / length / longueur	
	-074	74 mm Länge / length / longueur	
	-075	75 mm Länge / length / longueur	
	-076	76 mm Länge / length / longueur	
	-077	77 mm Länge / length / longueur	
	-078	78 mm Länge / length / longueur	
	-079	79 mm Länge / length / longueur	
	-080	80 mm Länge / length / longueur	
	-101	101 mm Länge / length / longueur	
	-102	102 mm Länge / length / longueur	
	-103	103 mm Länge / length / longueur	
	-104	104 mm Länge / length / longueur	
	-105	105 mm Länge / length / longueur	
	-106	106 mm Länge / length / longueur	
	-107	107 mm Länge / length / longueur	
	-108	108 mm Länge / length / longueur	
-109	109 mm Länge / length / longueur		
-110	110 mm Länge / length / longueur		
-111	111 mm Länge / length / longueur		
-112	112 mm Länge / length / longueur		
-113	113 mm Länge / length / longueur		
-114	114 mm Länge / length / longueur		
-115	115 mm Länge / length / longueur		
-116	116 mm Länge / length / longueur		
-117	117 mm Länge / length / longueur		
	3.230 186	ABSTANDSHALTER EDELSTAHL zum Kürzen, 0,22 x 8 mm für Laufwagen 3.234 135 000, 3.230 079 000, 3.230 184 000 LINK SPACER FINE STEEL for cutting to size, 0,22 x 8 mm for runner 3.234 135 000, 3.230 079 000, 3.230 184 000 ÉCARTEUR ACIER INOXYDABLE à découper, 0,22 x 8 mm pour chariot 3.234 135 000, 3.230 079 000, 3.230 184 000	1.000 Stck 1.000 pcs 1.000 pcs
	-139	139 mm Länge / length / longueur	
	-200	200 mm Länge / length / longueur	
	3.234 141 200	ABSTANDSHALTER EDELSTAHL, für Slope, 0,3 mm, 200 mm, für Laufwagen 3.234 136 000 und in Verbindung mit Schuh 3.234 141 000 LINK SPACER FINE STEEL, for Slope, 0,3 mm, 200 mm, for runner 3.234 136 000 and to be combined with base 3.234 141 000 ÉCARTEUR ACIER INOXYDABLE, pour Slope, 0,3 mm, 200 mm, pour chariot 3.234 136 000 et à combiner avec coussinet 3.234 141 000	1.000 Stck 1.000 pcs 1.000 pcs

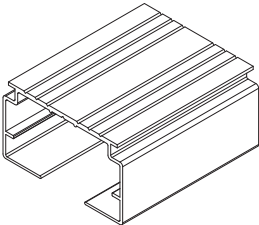
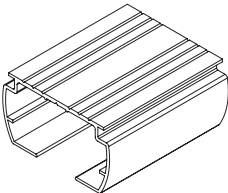
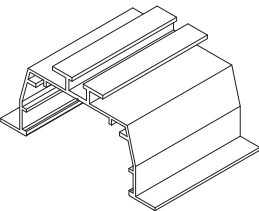
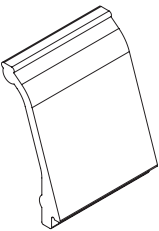
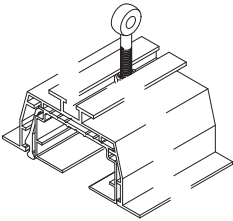
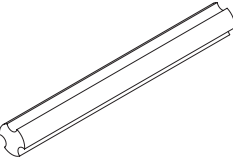
Abbildung Illustration Illustration	Artikelnr. Article No. Code Article	Artikelbezeichnung Designation Désignation	Packeinheit Packing Unit Conditionnement
	3.234 141 000	SCHUH FÜR STAHLABSTANDSHALTER 3.234 141 200 BASE FOR STEEL LINK 3.234 141 200 COUSSINET POUR ÉCARTEUR EN ACIER 3.234 141 200	1.000 Stck 1.000 pcs 1.000 pcs
	3.234 149 000	SLOPE-LAUFWAGEN SLOPE-RUNNER CHARIOT SLOPE	2.000 Stck 2.000 pcs 2.000 pcs
	3.235 -018 000 -019 000 -020 000 -034 000	SLOPE-HAKEN, transparent SLOPE-HOOK, transparent CROCHET SLOPE, transparent kurz / short / court mittel / medium / moyen lang / long / long extra lang / extra long / extra long	300 Stck 300 pcs 300 pcs
	3.234 157 -200	ABSTANDSHALTER EDELSTAHL zum Kürzen, 0,22x8 mm, für Laufwagen 3.234 149 000 LINK SPACER FINE STEEL for cutting to Size, 0,22x8 mm, for runner 3.234 149 000 ÉCARTEUR ACIER SURFIN à découper sur mesure, 0,22x8 mm, pour chariot 3.234 149 000 200 mm Länge / 200 mm length / 200 mm longueur	1.000 Stck 1.000 pcs 1.000 pcs
	3.233 -201 001 -202 001 -201 010 -202 010	ENDKAPPEN-SET, AS/NS, Compact END CAP SET, OPERATING / NON-OPERATING END, Compact JEU D'EMBOUTS, CÔTÉ COMMANDE / NON-COMMANDE, Compact rechts-weiß / right-white / droite-blanc links-weiß / left-white / gauche-blanc rechts-grau / right-grey / droite-gris links-grau / left-grey / gauche-gris	250 Satz 250 sets 250 jeux
	3.233 -232 001 -231 001 -232 010 -231 010 -232 049	ENDKAPPEN-SET, AS/NS, Omega END CAP SET, OPERATING / NON-OPERATING END, Omega JEU D'EMBOUTS, CÔTÉ COMMANDE / NON-COMMANDE, Omega rechts-weiß / right-white / droite-blanc links-weiß / left-white / gauche-blanc rechts-grau / right-grey / droite-gris links-grau / left-grey / gauche-gris rechts-schwarz / right-black / droite-noir	250 Satz 250 sets 250 jeux

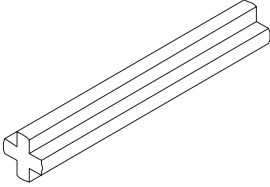
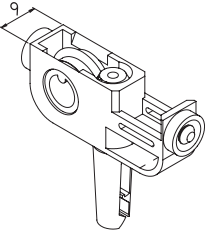
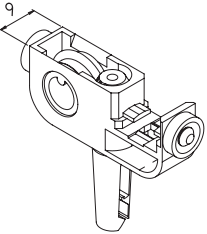
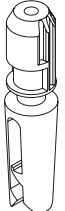
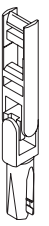

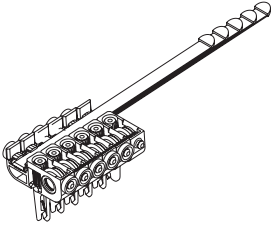
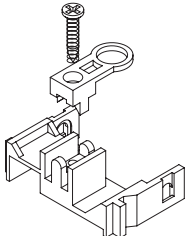
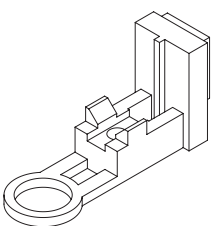
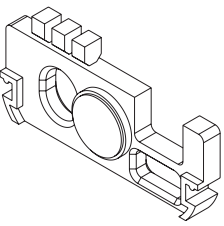
Abbildung Illustration Illustration	Artikelnr. Article No. Code Article	Artikelbezeichnung Designation Désignation	Packeinheit Packing Unit Conditionnement
	3.233 -303 001 -303 010 -304 001 -304 010	SLOPE ENDKAPPEN-SET, Compact SLOPE END CAP SET, Compact JEU D'EMBOUITS SLOPE, Compact rechts-weiß / right-white / droite-blanc rechts-grau / right-grey / droite-gris links-weiß / left-white / gauche-blanc links-grau / left-grey / gauche-gris	50 Satz 50 sets 50 jeux
	3.233 -234 001 -235 001 -234 010 -235 010 -235 049	SLOPE ENDKAPPEN-SET, Omega SLOPE END CAP SET, Omega JEU D'EMBOUITS SLOPE, Omega links-weiß / left-white / gauche-blanc rechts-weiß / right-white / droite-blanc links-grau / left-grey / gauche-gris rechts-grau / right-grey / droite-gris rechts-schwarz / right-black / droite-noir	50 Satz 50 sets 50 jeux
	3.233 300 000	SCHRAUBEN-SET FÜR SLOPE-ENDKAPPEN-SET Compact und Omega SCREW SET FOR SLOPE END CAP SET Compact and Omega JEU DE VIS POUR JEU D'EMBOUITS SLOPE Compact et Omega	50 Satz 50 sets 50 jeux
	3.233 236 000	PAKETAUSRÄSTUNG AUS NIROSTA für Laufwagen 3.234 136 000, 3.234 135 000 und 3.230 184 000 BUNCH RELEASE, STAINLESS STEEL for runner 3.234 136 000, 3.234 135 000 and 3.230 184 000 DÉCLENCHÉUR DU PAQUET, EN ACIER INOX pour chariot 3.234 136 000, 3.234 135 000 et 3.230 184 000	100 Stck 100 pcs 100 pcs
	3.233 238 -003 -005 -009 -021 -025 -051	DISTANZROHR SPACER TUBE TUBE DE DISTANCE 3 mm Länge / length / longueur 5 mm Länge / length / longueur 9 mm Länge / length / longueur 21 mm Länge / length / longueur 25 mm Länge / length / longueur 51 mm Länge / length / longueur	500 Stck 500 pcs 500 pcs
	3.233 214 000	STOPPRING, Kunststoff STOP RING, plastic BAGUE D'ARRÊT, plastique	2.000 Stck 2.000 pcs 2.000 pcs

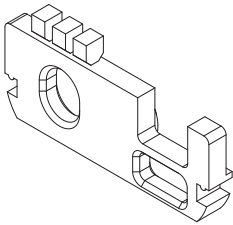
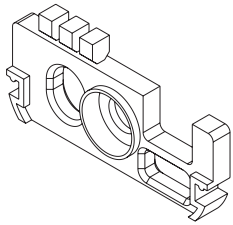
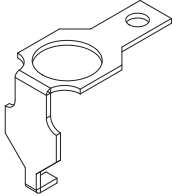
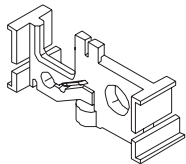
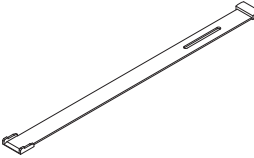

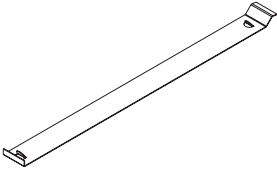
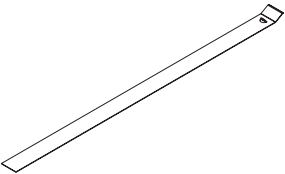
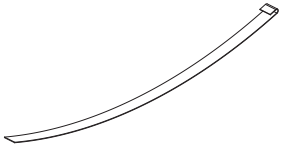

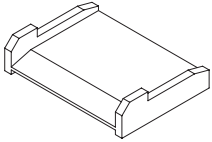
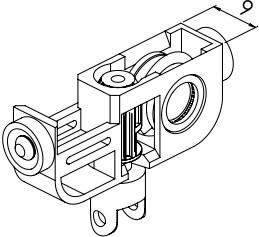
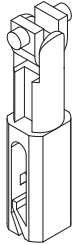
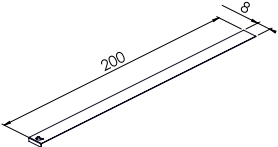
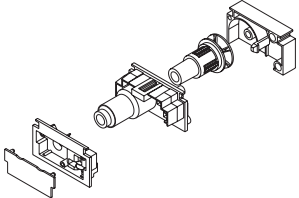
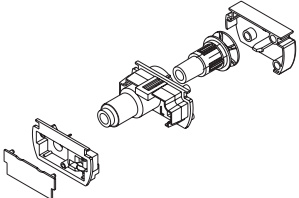
Abbildung Illustration Illustration	Artikelnr. Article No. Code Article	Artikelbezeichnung Designation Désignation	Packeinheit Packing Unit Conditionnement
	3.233 240 000	STOPPRING MIT AUGEN, Kunststoff STOP RING WITH EYES, plastic BAGUE D'ARRÊT AVEC OEILLETES, plastique	5.000 Stck 5.000 pcs 5.000 pcs
	3.233 218 000	STELLRING mit Gewindestift, Metall SET COLLAR with threaded pin, metal BAGUE DE RÉGLAGE avec tige filetée, métal	100 Stck 100 pcs 100 pcs
	3.233 215 000	FÄCHERFEDER, 6 mm, NS RETAINING WASHER, 6 mm, non operating end BAGUE DE FIXATION, 6 mm, coté non-commande	1.000 Stck 1.000 pcs 1.000 pcs
	3.233 246 000	FÄCHERFEDER, 6 mm, AS RETAINING WASHER, 6 mm, operating end BAGUE DE FIXATION, 6 mm, coté commande	1.000 Stck 1.000 pcs 1.000 pcs
	3.233 230 000	SICHERUNGSRING, AS, Metall SECURITY RING, operating side, metal BAGUE DE SECURITÉ, coté commande, métal	1.000 Stck 1.000 pcs 1.000 pcs
	3.233 216 000	WELLENSTIFT, Slope SHAFT PIN, Slope TIGE POUR ARBRE, Slope	100 Stck 100 pcs 100 pcs
	3.233 219 000	BLINDNIETE für Slope Wellenstütze, 3 x 6 mm BLIND RIVET for Slope shaft support, 3 x 6 mm RIVET AVEUGLE pour support d'arbre Slope, 3 x 6 mm	100 Stck 100 pcs 100 pcs
	3.233 220 000	SENKKOPF-BLINDNIETE für Magnetwellenstütze 3,2 x 6 mm COUNTERSUNK BLIND RIVET for magnet shaft support 3,2 x 6 mm RIVET AVEUGLE À TÊTE CONIQUE pour support d'arbre magnétique 3,2 x 6 mm	1.000 Stck 1.000 pcs 1.000 pcs
	3.002 000 121	BLINDNIETE für Magnetwellenstütze 3x5 mm COUNTERSUNK BLIND RIVET for magnet shaft support 3x5 mm RIVET AVEUGLE À TETE CONIQUE pour support d'arbre magnétique 3x5 mm	1.000 Stck 1.000 pcs 1.000 pcs

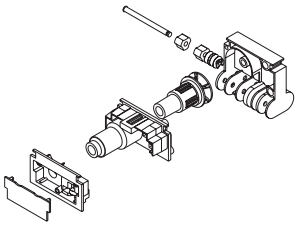
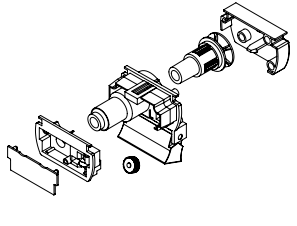
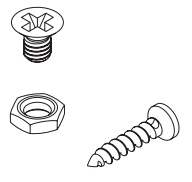
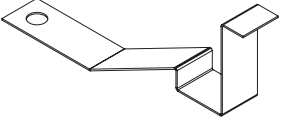
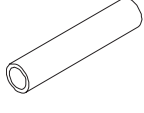
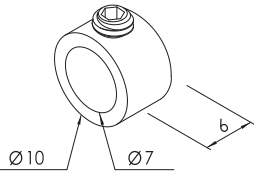
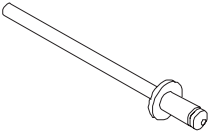
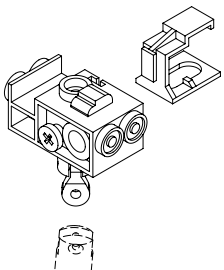
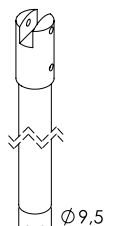
Abbildung Illustration Illustration	Artikelnr. Article No. Code Article	Artikelbezeichnung Designation Désignation	Packeinheit Packing Unit Conditionnement
	3.233 252 -001	SCHLEUDERSTABGETRIEBE SPIN WAND GEAR UNIT ENGRENAGE POUR MANETTE D'ORIENTATION weiß / white / blanc	100 Stck 100 pcs 100 pcs
	3.233 253 -001	SCHLEUDERSTAB 1.500 mm SPIN WAND 1.500 mm MANETTE D'ORIENTATION 1.500 mm weiß / white / blanc	100 Stck 100 pcs 100 pcs