

Nr. No. Code	Artikelnr. Article No. Code Article	Artikelbezeichnung Designation Designation	Nr. No. Code	Artikelnr. Article No. Code Article	Artikelbezeichnung Designation Designation
01	3.233.770.001	Laufschiene / Headrail / Boitier	10	3.233.220.000	Blindniete / Blind rivet / Rivet
02	3.233.671.000	Wendeachse / Tilt shaft / Axe d'orientation	11	3.233.238.xxx	Distanzrohr / Spacer tube / Tube de distance
03	3.233.903.001	Elektromotor / Electrical motor / Moteur électrique	12	3.233.240.000	Stoppring / Stop ring / Bague d'arrêt
04	3.234.136.000	Laufwagen / Runner / Chariot	13	3.233.200.001	Endkappen-Set / End cap set / Jeu d'Embouts
05	3.233.229.xxx	Abstandshalter / Link spacer / Ecarteur	14	3.233.215.000	Fächerfeder / Retaining washer / Bague de fixation
06	3.234.139.000	Schnurzugwagen / Cord drive runner / Chariot de tirage	15	3.224.005.001	Antriebskette / Drive chain / Chaîne de transmission
07	3.233.210.000	Magnethalter / Magnet holder / Support magnétique	16	3.233.226.001	Abstandskette / Bottom chain / Chaîn de transmission
08	3.233.207.001	Magnetwellenstütze / Magnet shaft support / Support d'arbre	17	3.233.225.001	Beschwerungsplatte / Bottom weight / Plaque de lestage
09	3.233.208.000	Magnetwellenstütze / Magnet shaft support / Support d'arbre	18	3.233.221.090	Lamellenhalter / Slat holder / Support lamelle
			19	3.230.176.001	Montageclip / Fixing clip / Clip de montage

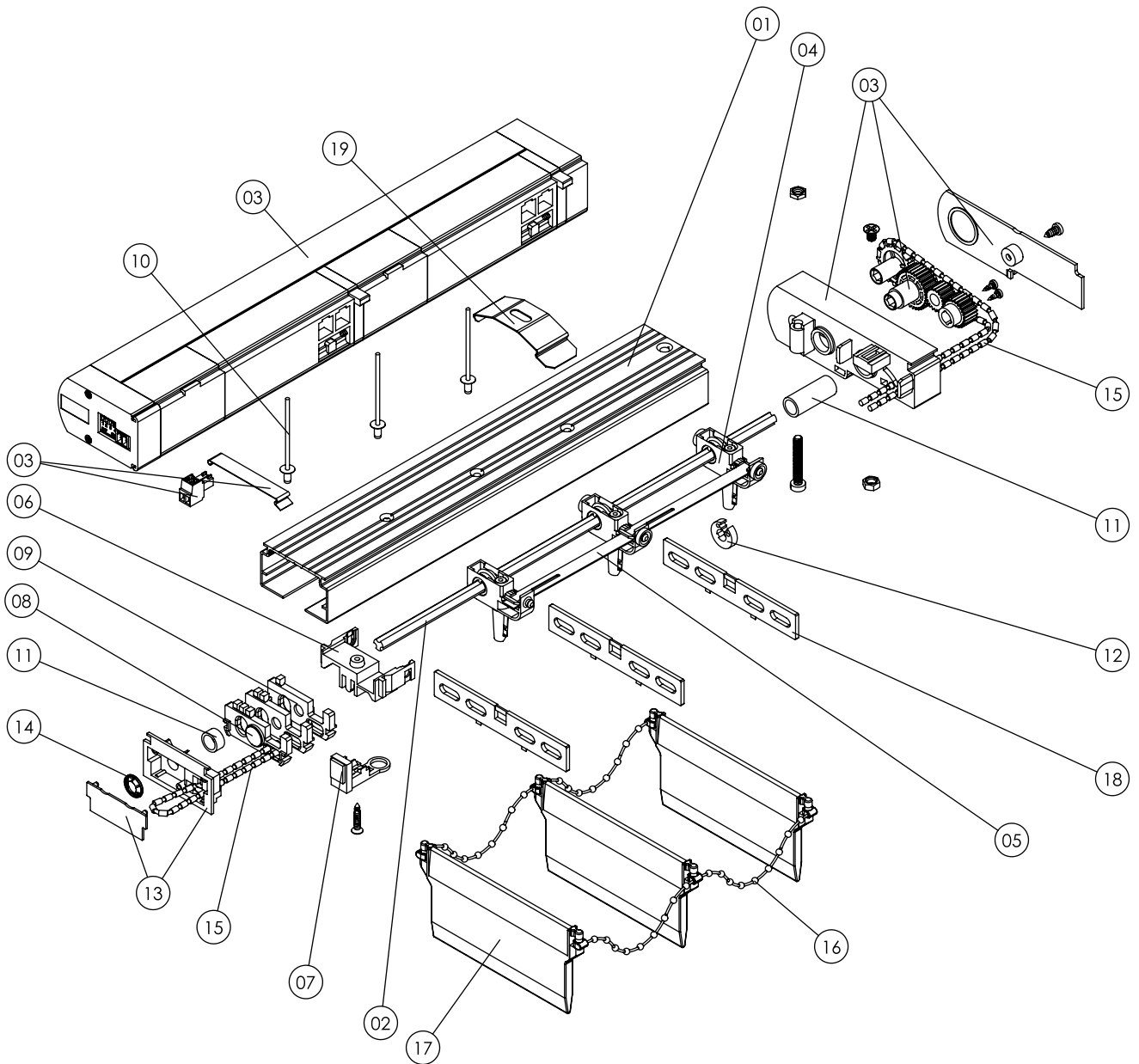

ELEKTRO KOMPONENTEN
ELECTRICAL COMPONENTS
ÉLÉMENTS DE MOTORISATION





Abbildung Illustration Illustration	Artikelnr. Article No. Code Article	Artikelbezeichnung Designation Designation	Packeinheit Packing Unit Conditionnement
	3.224.005.001	ANTRIEBSKETTE FÜR VERTIKALMOTOR, weiß DRIVE CHAIN FOR MOTOR VERTICAL BLIND, white CHAÎNE DE TRANSMISSION POUR MOTEUR STORES, blanc	250 m 250 m 250 m
	3.233	ENDKAPPEN-SET NS, für Elektromotor END CAP SET NON OPERATING END, for electrical motor JEU D'EMBOUS, CÔTÉ NON-COMMANDE, pour moteur électrique	1 Stck 1 pce 1 pce
	-903.001	links, weiß / left, white / gauche, blanc	
	-904.001	rechts, weiß / right, white / droite, blanc	
	3.233	ENDKAPPEN-SET NS, für Elektromotor END CAP SET NON OPERATING END, for electrical motor JEU D'EMBOUS, CÔTÉ NON-COMMANDE, pour moteur électrique	10 Satz 10 sets 10 jeux
	-199.001	links, weiß / left, white / gauche, blanc	
	-200.001	rechts, weiß / right, white / droite, blanc	
	3.233	OMEGA ENDKAPPEN-SET NS, für Elektromotor OMEGA ENDCAP SET NON OPERATING END, for electrical Motor OMEGA JEU D'EMBOUS, COTÉ NON COMMAND, pour moteur électrique	10 Satz 10 sets 10 jeux
	-195.001	links, weiß / left, white / gauche, blanc	
	-196.001	rechts, weiß / right, white / droite, blanc	
	3.233.955.001	Steckernetzteil 230V AC/24V DC 1 A für max. 2 Antriebe, weiß Plug-in power supply 230V AC/24V DC 1 A for max. 2 units, white Alimentation enfichable 230V AC/24V DC 1 A pour 2 unités max., blanc	1 Stck 1 pcs 1 pcs
	3.233.931.000	SCHALTERNETZTEIL Inis DC Rollo (Somfy 1 870 071) für 1 Anlage, weiß POWER SUPPLY with built-in switch, Inis DC roller, for 1 unit, white ALIMENTATION avec interrupteur intégré, Inis DC roller, pour 1 unité, blanc	1 Stck 1 pcs 1 pcs
	3.233.930.001	inteo AUFPUTZKAPPE (Somfy 9 102 004), weiß inteo SURFACE MOUNTING BOX "Ines DC roller", white BOÎTIER EN SAILLIE "Inteo" gris, "Ines DC roller", blanc	1 Stck 1 pcs 1 pcs
	3.233.933.000	FUNK-HANDESENDER 1-KANAL "Telis RTS 1" (Somfy 1 810 630), weiß RADIO REMOTE CONTROL TRANSMITTER "Telis 1 RTS", white TÉLÉCOMMANDE "Telis 1 RTS", blanc	1 Stck 1 pcs 1 pcs
	3.233.934.000	FUNK-HANDESENDER 5-KANAL "Telis 5 RTS" (Somfy 1 810 631), weiß RADIO REMOTE CONTROL TRANSMITTER "Telis 5 RTS", white TÉLÉCOMMANDE "Telis 5 RTS", blanc	1 Stck 1 pcs 1 pcs

Abbildung Illustration Illustration	Artikelnr. Article No. Code Article	Artikelbezeichnung Designation Designation	Packeinheit Packing Unit Conditionnement
	3.233.954.000	FUNK-HANDESENDER mit Scrollrad 5-Kanal Telis 5 RTS Pure (Somfy 1 810 765)	1 Stck
		RADIO-CONTROL, with scroll wheel, control 5-channel Telis 5 RTS Pure (Somfy 1810765)	1 pcs
		TÉLÉCOMMANDE, avec bouton de roulette, Telis 5 pour variation RTS Pure (Somfy 1 810 974)	1 pcs
	3.233.932.000	FUNKEMPFÄNGER, für max. 2 Anlagen, "Modul DC RTS" (Somfy 1 870 016), weiß	1 Stck
		RADIO RECEIVER, for max 2. units "modul DC RTS", white	1 pcs
		RÉCEPTEUR "MODULE DC RTS", pour max 2 stores, blanc	1 pcs

Weiterhin ist ein umfangreiches Steuerungszubehör wie Gruppensteuerungen, Sonnenautomatik etc. von Somfy erhältlich

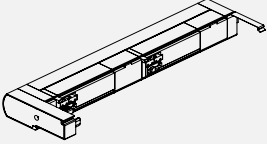
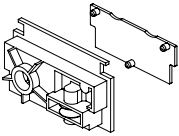
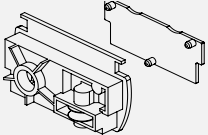
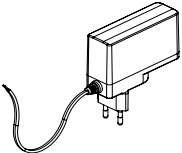
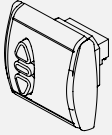
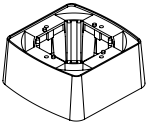
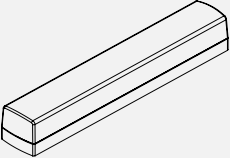
A wide range of control accessories such as group controls, automatic sun control, etc. are also available from Somfy

Une large gamme d'accessoires de régulation tels que les commandes groupées, le contrôle solaire automatique, etc. sont également disponibles chez Somfy