

Abbildung Illustration Illustration	Artikelnr. Article No. Code Article	Artikelbezeichnung Designation Designation	Packeinheit Packing Unit Conditionnement
	3.233.770	COMPACT-LAUFSCIENE, 44,5x25 mm, Aluminium COMPACT-HEADRAIL, 44,5x25 mm, aluminium BOÏTIER COMPACT, 44,5x25 mm, aluminium	70 m 70 m 70 m
	-001	weiß / white / blanc	Längen à 7 m lengths of 7 m longueurs de 7 m
	-058	eloxiert / anodized / anodisé	
	3.233.870	OMEGA-LAUFSCIENE, 44,5x25 mm, Aluminium OMEGA-HEADRAIL, 44,5x25 mm, aluminium BOÏTIER OMEGA, 44,5x25 mm, aluminium	70 m 70 m 70 m
	-001	weiß / white / blanc	Längen à 7 m lengths of 7 m longueurs de 7 m
	-049	schwarz / black / noir	
	-058	eloxiert / anodized / anodisé	
	3.233.775	EINBAUPROFIL für Systemdecken INSTALLATION-PROFILE for suspended ceilings PROFILÉ À ENCASTRER pour plafonds suspendus	56 m 56 m 56 m
	-001	weiß / white / blanc	Längen à 7 m lengths of 7 m longueurs de 7 m
	3.233.776	CLIP zur Montage der Laufschiene im Einbauprofil, Kunststoff CLIP for fixing the headrail to the installation profile, plastic CLIP pour montage du rail dans profilé à encastrer, plastique	50 Stck 50 pcs 50 pcs
	-001	weiß / white / blanc	
	3.233.777.000	MONTAGESET FÜR EINBAUPROFIL MOUNTING SET FOR INSTALLATION PROFILE KIT DE MONTAGE POUR PROFILÉ À ENCASTRER	50 Satz 50 sets 50 jeux
	3.233.671.000	WENDEACHSE, Aluminium, 6 mm, 3 Kant TILT SHAFT, aluminium, 6 mm, 3 edged AXE D'ORIENTATION, aluminium, 6 mm, 3 pans	70 m 70 m 70 m
			Längen à 7 m lengths of 7 m longueurs de 7 m
	3.233.670.000	WENDEACHSE, Aluminium, 6 mm, 4 Kant TILT SHAFT, aluminium, 6 mm, 4 edged AXE D'ORIENTATION, aluminium, 6 mm, 4 pans	70 m 70 m 70 m
			Längen à 7 m lengths of 7 m longueurs de 7 m



Abbildung Illustration Illustration	Artikelnr. Article No. Code Article	Artikelbezeichnung Designation Designation	Packeinheit Packing Unit Conditionnement
	3.234.135.000	LAUFWAGEN (9 mm) MIT AUSWECHSELBAREM TRANSPARENTEN KUNSTSTOFFHAKEN für Metallabstandshalter, verwendbar mit 3 und 4kant-Wendeachse RUNNER (9 mm) WITH CHANGEABLE TRANSPARENT PLASTIC HOOK for metal links and for 3 and 4 edged shafts CHARIOT (9 mm) AVEC CROCHET TRANSPARENT, ÉCHANGEABLE, pour écarteur métal et axes d'orientation à 3 et 4 pans	2.000 Stck 2.000 pcs 2.000 pcs
	3.234.136.000	LAUFWAGEN (9 mm) MIT AUSWECHSELBAREM TRANSPARENTEN KUNSTSTOFFHAKEN für Kunststoffabstandshalter, verwendbar mit 3 und 4kant-Wendeachse RUNNER (9 mm) WITH CHANGEABLE TRANSPARENT PLASTIC HOOK for plastic links and for 3 and 4 edged shafts CHARIOT (9 mm) AVEC CROCHET TRANSPARENT, ÉCHANGEABLE, pour écarteur plastique et axes d'orientation à 3 et 4 pans	2.000 Stck 2.000 pcs 2.000 pcs
	3.234.149.000	SLOPE-LAUFWAGEN SLOPE-RUNNER CHARIOT SLOPE	2.000 Stck 2.000 pcs 2.000 pcs
	3.234.137 -000	HAKEN FÜR LAUFWAGEN HOOK FOR RUNNER CROCHET POUR CHARIOT	100 Stck 100 pcs 100 pcs
	3.233 -305.000 -306.000	SLOPE-HAKEN, transparent, mit Kardangelenk für Laufwagen 3.234 136 000 und 3.234 140 000 (transparent) SLOPE HOOK, transparent, with cardan joint for runner 3.234 136 000 and 3.234 140 000 (transparent) CROCHET SLOPE, transparent, avec joint de cardan pour chariot 3.234 136 000 et 3.234 140 000 (transparent) kurz / short / court 35° lang / long / long 55°	100 Stck 100 Stck 100 Stck
	3.235 -018.000 -019.000 -020.000 -034.000	SLOPE-HAKEN, transparent, für Laufwagen 3.234.149.000 SLOPE-HOOK, transparent, for runner 3.234.149.000 CROCHET SLOPE, transparent, pour chariot 3.234.149.000 kurz / short / court mittel / medium / moyen lang / long / long extra lang / extra long / extra long	300 Stck 300 pcs 300 pcs

Abbildung Illustration Illustration	Artikelnr. Article No. Code Article	Artikelbezeichnung Designation Designation	Packeinheit Packing Unit Conditionnement
	3.234	SCHNURZUGWAGEN mit Klemmstück und Schraube für Laufwagen 3.234.136.000, 3.234.135.000, 3.230.184.000 und 3.234.149.000 CORD DRIVE RUNNER with clip and screw for carrier 3.234.136.000, 3.234.135.000, 3.230.184.000 and 3.234.149.000 CHARIOT DE TIRAGE DU CORDON avec clip et vis pour chariot 3.234.136.000, 3.234.135.000, 3.230.184.000 et 3.234.149.000	100 Stck 100 Stck 100 Stck
	-138.000	rechts / right / droite	
	-139.000	links / left / gauche	
	3.233	MAGNETHALTER für Schnurzugwagen 3.234.136.000, 3.234.135.000, 3.230.184.000 und 3.234.149.000 MAGNET HOLDER for cord drive runner 3.234.136.000, 3.234.135.000, 3.230.184.000 and 3.234.149.000 SUPPORT MAGNÉTIQUE pour chariot de tirage du cordon 3.234.136.000, 3.234.135.000, 3.230.184.000 et 3.234.149.000	100 Stck 100 Stck 100 Stck
	-209.001	rechts-weiß / right-white / droite-blanc	
	-210.001	links-natur / left-natural / gauche-naturel	
	3.233.207	MAGNETWELLENSTÜTZE, für Laufwagen 3.234.136.000, 3.234.135.000, 3.230.184.000 und 3.234.149.000 MAGNET SHAFT SUPPORT, for carrier 3.234.136.000, 3.234.135.000, 3.230.184.000 and 3.234.149.000 SUPPORT D'ARBRE MAGNÉTIQUE, pour chariot 3.234.136.000, 3.234.135.000, 3.230.184.000 et 3.234.149.000	100 Stck 100 Stck 100 Stck
	-001	rechts-weiß / right-white / droite-blanc	
	3.233.208	MAGNETWELLENSTÜTZE, für Laufwagen 3.234.136.000, 3.234.135.000, 3.230.184.000 und 3.234.149.000 MAGNET SHAFT SUPPORT, for carrier 3.234.136.000, 3.234.135.000, 3.230.184.000 and 3.234.149.000 SUPPORT D'ARBRE MAGNÉTIQUE, pour chariot 3.234.136.000, 3.234.135.000, 3.230.184.000 et 3.234.149.000	100 Stck 100 Stck 100 Stck
	-000	links-natur / left-natural / gauche-naturel	
	3.233.244.000	MITTELSTÜTZE, universal CENTRE SUPPORT, universal SUPPORT CENTRAL, universel	100 Stck 100 pcs 100 pcs
	3.233.307.000	SLOPE WELLENSTÜTZE für Laufwagen 3.234.135.000 und 3.234.149.000 SLOPE SHAFT SUPPORT for carrier for runner 3.234.135.000 and 3.234.149.000 SUPPORT D'ARBRE SLOPE pour chariot 3.234.135.000 et 3.234.149.000	100 Stck 100 pcs 100 pcs

Abbildung Illustration Illustration	Artikelnr. Article No. Code Article	Artikelbezeichnung Designation Designation	Packeinheit Packing Unit Conditionnement
	3.234	LAUFWAGENZUG, bestehend aus 100 Laufwagen 3.234.136.000 und Kunststoffabstandshaltern 3.233.229 XXX RUNNER TRACK, including 100 runners 3.234.136.000 and plastic spacer links 3.233.229 XXX TRAIN DE CHARIOTS, comprenant 100 chariots 3.234.136.000 et écarteurs en plastique 3.233.229 XXX	10 Stck 10 pcs 10 pcs
		-143.073	rechts 73 mm / right 73 mm / droite 73 mm
-144.073		links 73 mm / left 73 mm / gauche 73 mm	
-143.075		rechts 75 mm / right 75 mm / droite 75 mm	
-144.075		links 75 mm / left 75 mm / gauche 75 mm	
-143.078		rechts 78 mm / right 78 mm / droite 78 mm	
-144.078		links 78 mm / left 78 mm / gauche 78 mm	
-143.080		rechts 80 mm / right 80 mm / droite 80 mm	
-144.080		links 80 mm / left 80 mm / gauche 80 mm	
-143.106		rechts 106 mm / right 106 mm / droite 106 mm	
-144.106		links 106 mm / left 106 mm / gauche 106 mm	
-143.110		rechts 110 mm / right 110 mm / droite 110 mm	
-144.110		links 110 mm / left 110 mm / gauche 110 mm	
-143.114		rechts 114 mm / right 114 mm / droite 114 mm	
-144.114	links 114 mm / left 114 mm / gauche 114 mm		
-143.117	rechts 117 mm / right 117 mm / droite 117 mm		
-144.117	links 117 mm / left 117 mm / gauche 117 mm		
	3.233.229	ABSTANDSHALTER, Kunststoff, für Laufwagen 3.234.136.000 LINK SPACER, plastic, for runner 3.234.136.000 ÉCARTEUR, plastique, pour chariot 3.234.136.000	1.000 Stck 1.000 pcs 1.000 pcs
	-073	73 mm Länge / length / longueur	
	-075	75 mm Länge / length / longueur	
	-078	78 mm Länge / length / longueur	
	-080	80 mm Länge / length / longueur	
	-106	106 mm Länge / length / longueur	
	-110	110 mm Länge / length / longueur	
	-114	114 mm Länge / length / longueur	
-117	117 mm Länge / length / longueur		
	3.230.186	ABSTANDSHALTER EDELSTAHL zum Kürzen, 0,22 x 8 mm für Laufwagen 3.234.135.000, 3.234.149.000, 3.230.184.000 LINK SPACER FINE STEEL for cutting to size, 0,22 x 8 mm for runner 3.234.135.000, 3.234.149.000, 3.230.184.000 ÉCARTEUR ACIER INOXYDABLE à découper, 0,22 x 8 mm pour chariot 3.234.135.000, 3.234.149.000, 3.230.184.000	1.000 Stck 1.000 pcs 1.000 pcs
	-139	139 mm Länge / length / longueur	
	-200	200 mm Länge / length / longueur	

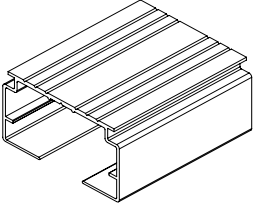
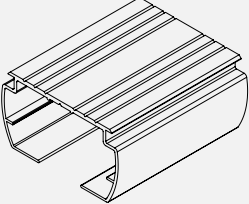
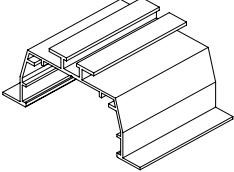
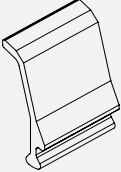
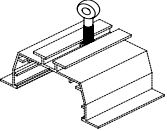
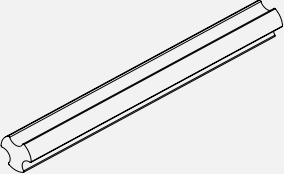
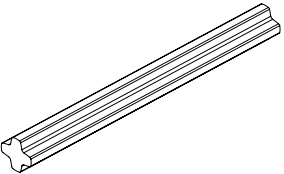

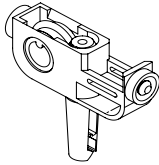
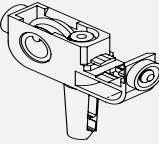
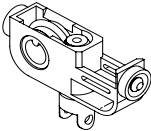
Abbildung Illustration Illustration	Artikelnr. Article No. Code Article	Artikelbezeichnung Designation Designation	Packeinheit Packing Unit Conditionnement	
	3.234.156	ABSTANDSHALTER EDELSTAHL, 0,22 x 8 mm für Laufwagen 3.234.135.000 und 3.230.184.000 LINK SPACER FINE STEEL, 0,22 x 8 mm for runner 3.234.135.000 and 3.230.184.000 ÉCARTEUR ACIER INOXYDABLE, 0,22 x 8 mm pour chariot 3.234.135.000 et 3.230.184.000	1.000 Stck 1.000 pcs 1.000 pcs	
	-070	70 mm Länge / length / longueur		
	-071	71 mm Länge / length / longueur		
	-072	72 mm Länge / length / longueur		
	-073	73 mm Länge / length / longueur		
	-074	74 mm Länge / length / longueur		
	-075	75 mm Länge / length / longueur		
	-076	76 mm Länge / length / longueur		
	-077	77 mm Länge / length / longueur		
	-078	78 mm Länge / length / longueur		
	-079	79 mm Länge / length / longueur		
	-080	80 mm Länge / length / longueur		
	-101	101 mm Länge / length / longueur		
	-102	102 mm Länge / length / longueur		
	-103	103 mm Länge / length / longueur		
	-104	104 mm Länge / length / longueur		
	-105	105 mm Länge / length / longueur		
	-106	106 mm Länge / length / longueur		
	-107	107 mm Länge / length / longueur		
-108	108 mm Länge / length / longueur			
-109	109 mm Länge / length / longueur			
-110	110 mm Länge / length / longueur			
-111	111 mm Länge / length / longueur			
-112	112 mm Länge / length / longueur			
-113	113 mm Länge / length / longueur			
-114	114 mm Länge / length / longueur			
-115	115 mm Länge / length / longueur			
-116	116 mm Länge / length / longueur			
-117	117 mm Länge / length / longueur			
	3.234.141.200	ABSTANDSHALTER EDELSTAHL, für Slope, 0,3 mm, 200 mm, für Laufwagen 3.234.136.000 und in Verbindung mit Schuh 3.234.141.000 LINK SPACER FINE STEEL, for Slope, 0.3 mm, 200 mm, for runner 3.234.136.000 and to be combined with base 3.234.141.000 ÉCARTEUR ACIER INOXYDABLE, pour Slope, 0,3 mm, 200 mm, pour chariot 3.234.136.000 et à combiner avec coussinet 3.234.141.000	1.000 Stck 1.000 pcs 1.000 pcs	
		3.234.141.000	SCHUH FÜR STAHLABSTANDSHALTER 3.234 141 200 BASE FOR STEEL LINK 3.234 141 200 COUSSINET POUR ÉCARTEUR EN ACIER 3.234 141 200	1.000 Stck 1.000 pcs 1.000 pcs
	3.234.157	ABSTANDSHALTER EDELSTAHL zum Kürzen, 0,22x8 mm, für Laufwagen 3.234.149.000 LINK SPACER FINE STEEL for cutting to Size, 0,22x8 mm, for runner 3.234.149.000 ÉCARTEUR ACIER SURFIN à découper sur mesure, 0,22x8 mm, pour chariot 3.234.149.000	1.000 Stck 1.000 pcs 1.000 pcs	
	-200	200 mm Länge / 200 mm length / 200 mm longueur		

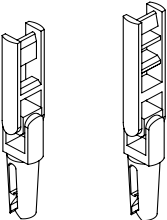
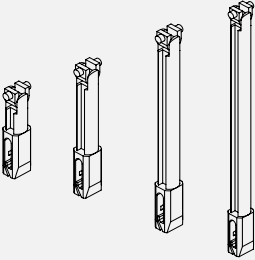
Abbildung Illustration Illustration	Artikelnr. Article No. Code Article	Artikelbezeichnung Designation Designation	Packeinheit Packing Unit Conditionnement
	3.233.	ENDKAPPEN-SET, AS/NS, Compact END CAP SET, OPERATING / NON-OPERATING END, Compact JEU D'EMBOUTS, CÔTÉ COMMANDE / NON-COMMANDE, Compact	250 satz 250 sets 250 jeux
	-201.001	rechts-weiß / right-white / droite-blanc	
	-202.001	links-weiß / left-white / gauche-blanc	
	-201.010	rechts-grau right-grey / droite-gris	
	-202.010	links-grau / left-grey / gauche-gris	
	3.233	ENDKAPPEN-SET, AS/NS, Omega END CAP SET, OPERATING / NON-OPERATING END, Omega JEU D'EMBOUTS, CÔTÉ COMMANDE / NON-COMMANDE, Omega	250 satz 250 sets 250 jeux
	-232.001	rechts-weiß / right-white / droite-blanc	
	-231.001	links-weiß / left-white / gauche-blanc	
	-232.010	rechts-grau right-grey / droite-gris	
	-231.010	links-grau / left-grey / gauche-gris	
	3.233	SLOPE ENDKAPPEN-SET, Compact SLOPE END CAP SET, Compact JEU D'EMBOUTS SLOPE, Compact	50 Satz 50 sets 50 jeux
	-303.001	rechts-weiß / right-white / droite-blanc	
	-303.010	rechts-grau / right-grey / droite-gris	
	-304.001	links-weiß / left-white / gauche-blanc	
	-304.010	links-grau / left-grey / gauche-gris	
	3.233	SLOPE ENDKAPPEN-SET, Omega SLOPE END CAP SET, Omega JEU D'EMBOUTS SLOPE, Omega	50 Satz 50 sets 50 jeux
	-234.001	links-weiß / left-white / gauche-blanc	
	-235.001	rechts-weiß / right-white / droite-blanc	
	-234.010	links-grau / left-grey / gauche-gris	
	-235.010	rechts-grau / right-grey / droite-gris	
	3.233.300.000	SCHRAUBEN-SET FÜR SLOPE-ENDKAPPEN-SET Compact und Omega SCREW SET FOR SLOPE END CAP SET Compact and Omega JEU DE VIS POUR JEU D'EMBOUTS SLOPE Compact et Omega	50 Satz 50 sets 50 jeux

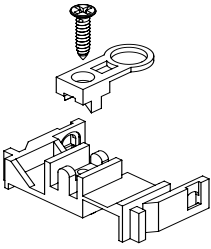
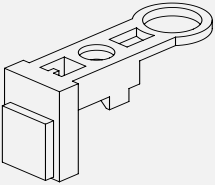
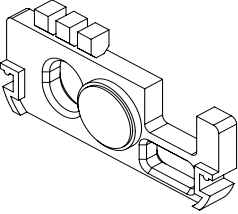
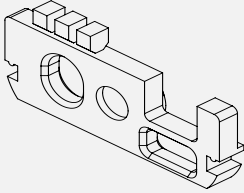
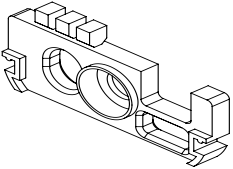
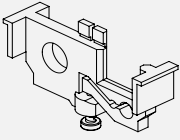

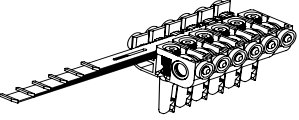
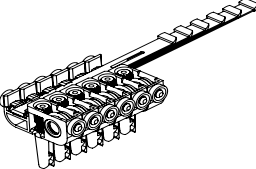
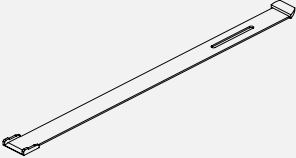
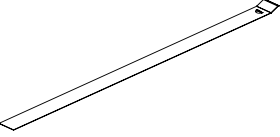

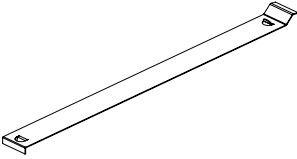

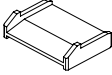
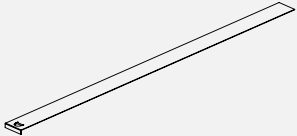
Abbildung Illustration Illustration	Artikelnr. Article No. Code Article	Artikelbezeichnung Designation Designation	Packeinheit Packing Unit Conditionnement
	3.233.236.000	PAKETAUSRÄSTUNG AUS NIROSTA für Laufwagen 3.234.136.000, 3.234.135.000 und 3.230.184.000	100 Stck
		BUNCH RELEASE, STAINLESS STEEL for runner 3.234.136.000, 3.234.135.000 and 3.230.184.00	100 pcs
		DÉCLENCHÉUR DU PAQUET, EN ACIER INOX pour chariot 3.234.136.000, 3.234.135.000 et 3.230.184.000	100 pcs
	3.233.238	DISTANZROHR SPACER TUBE TUBE DE DISTANCE	500 Stck 500 pcs 500 pcs
	-003	3 mm Länge / length / longueur	
	-005	5 mm Länge / length / longueur	
	-009	9 mm Länge / length / longueur	
	-021	21 mm Länge / length / longueur	
	-025	25 mm Länge / length / longueur	
-051	51 mm Länge / length / longueur		
	3.233.214.000	STOPPRING, Kunststoff STOP RING, plastic BAGUE D'ARRÊT, plastique	2.000 Stck 2.000 pcs 2.000 pcs
	3.233.240.000	STOPPRING MIT AUGEN, Kunststoff STOP RING WITH EYES, plastic BAGUE D'ARRÊT AVEC OEILLETES, plastique	5.000 Stck 5.000 pcs 5.000 pcs
	3.233.218.000	STELLRING mit Gewindestift, Metall SET COLLAR with threaded pin, metal BAGUE DE RÉGLAGE avec tige filetée, métal	100 Stck 100 pcs 100 pcs
	3.233.215.000	FÄCHERFEDER, 6 mm, NS RETAINING WASHER, 6 mm, non operating end BAGUE DE FIXATION, 6 mm, coté non-commande	1.000 Stck 1.000 pcs 1.000 pcs
	3.233.246.000	FÄCHERFEDER, 6 mm, AS RETAINING WASHER, 6 mm, operating end BAGUE DE FIXATION, 6 mm, coté commande	1.000 Stck 1.000 pcs 1.000 pcs
	3.233.230.000	SICHERUNGSRING, AS, Metall SECURITY RING, operating side, metal BAGUE DE SÉCURITÉ, coté commande, métal	1.000 Stck 1.000 pcs 1.000 pcs
	3.233.216.000	WELLENSTIFT, Slope SHAFT PIN, Slope TIGE POUR ARBRE, Slope	100 Stck 100 pcs 100 pcs

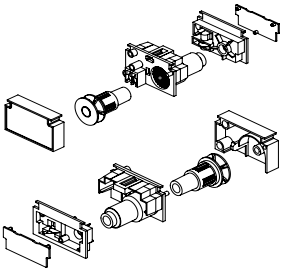
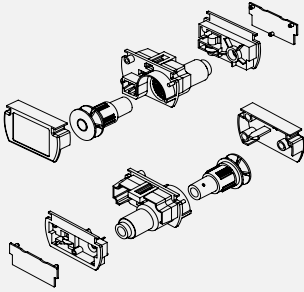
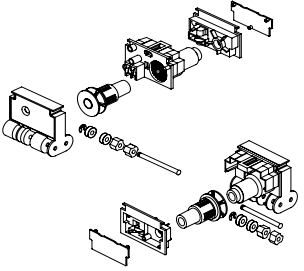
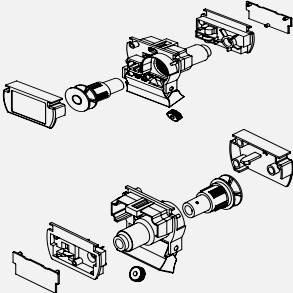
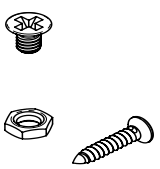
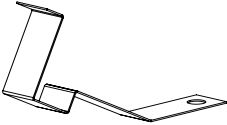
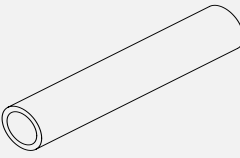
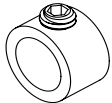
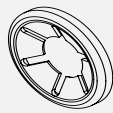
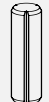
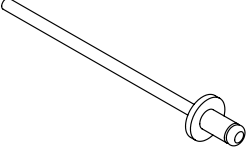
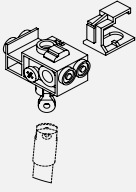
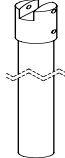
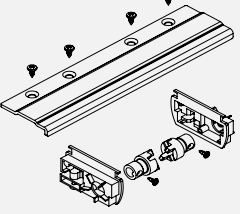
Abbildung Illustration Illustration	Artikelnr. Article No. Code Article	Artikelbezeichnung Designation Designation	Packeinheit Packing Unit Conditionnement
	3.233.219.000	BLINDNIETE für Slope Wellenstütze, 3 x 6 mm BLIND RIVET for Slope shaft support, 3 x 6 mm RIVET AVEUGLE pour support d'arbre Slope, 3 x 6 mm	100 Stck 100 pcs 100 pcs
	3.233.220.000	SENKKOPF-BLINDNIETE für Magnetwellenstütze 3,2 x 6 mm COUNTERSUNK BLIND RIVET for magnet shaft support 3,2 x 6 mm RIVET AVEUGLE À TÊTE CONIQUE pour support d'arbre magnétique 3,2 x 6 mm	1.000 Stck 1.000 pcs 1.000 pcs
	3.002.000.121	BLINDNIETE für Magnetwellenstütze 3x5 mm COUNTERSUNK BLIND RIVET for magnet shaft support 3x5 mm RIVET AVEUGLE À TÊTE CONIQUE pour support d'arbre magnétique 3x5 mm	1.000 Stck 1.000 pcs 1.000 pcs
	3.233.252	SCHLEUDERSTABGETRIEBE SPIN WAND GEAR UNIT ENGRENAGE POUR MANETTE D'ORIENTATION	100 Stck 100 pcs 100 pcs
	-001	weiß / white / blanc	
	3.233.253	SCHLEUDERSTAB 1.500 mm SPIN WAND 1.500 mm MANETTE D'ORIENTATION 1.500 mm	100 Stck 100 pcs 100 pcs
	-001	weiß / white / blanc	
	3.230.220	SCHIENENVERBINDER SET, OMEGA RAIL CONNECTOR SET, OMEGA JEU DE CONNECTEURS DE RAIL, OMEGA	10 Satz 10 sets 10 jeux
	-001	weiß / white / blanc	
	-011	grau / grey / gris	
	-049	schwarz / black / noir	
	3.230.221	SCHIENENVERBINDER SET, Compact RAIL CONNECTOR SET, Compact JEU DE CONNECTEURS DE RAIL, Compact	10 Satz 10 sets 10 jeux
	-001	weiß / white / blanc	
	-011	grau / grey / gris	