

Nr. No. Code	Artikelnr. Article No. Code Article	Artikelbezeichnung Designation Designation	Nr. No. Code	Artikelnr. Article No. Code Article	Artikelbezeichnung Designation Designation
01	3.235.001.001	Laufschiene / Headrail / Boitier	11	3.235.028.001	Zugschnur / Pull cord / Cordon
02	3.235.005.000	Nutwelle / Slotted shaft / Axe à rainure	12	3.224.003.001	Bedienkette / Operating chain / Chainette de commande
03	3.235.012.001	Endkappen-Set / End cap set / Jeu d'Embouts	13	3.232.129.000	Kettenverbinder / Ball chain connector / Joint de chaîne
04	3.235.016.001	Laufwagen / Runner / Chariot	14	3.233.226.001	Abstandskette / Bottom chain / Chainette du bas
05	3.235.011.xxx	Abstandshalter / Link spacer / Écarteur	15	3.233.225.001	Beschwerungsplatte / Bottom weight / Plaque de lestage
06	3.235.021.001	Schnurzugwagen / Cord drive runner / Chariot de tirage	16	3.233.221.090	Lamellenhalter / Slat holder / Support lamelle
07	3.235.023.001	Klappwellenstütze / Shaft support / Support d'arbre	17	3.230.185.001	Montageclip / Fixing clip / Clip de montage
08	3.235.011.030	Abstandshalter / Link spacer / Ecarteur	18	3.230.174.001	Schnurbeschwerer / Cord weight / Poids de cordon
09	3.235.037.001	Beweglicher Pakethalter / Moveable bunch-spacer / Porte-paquet mobile			
10	3.235.027.001	Auflaufstopper / End retainer / Arrêt fin de boîtier			

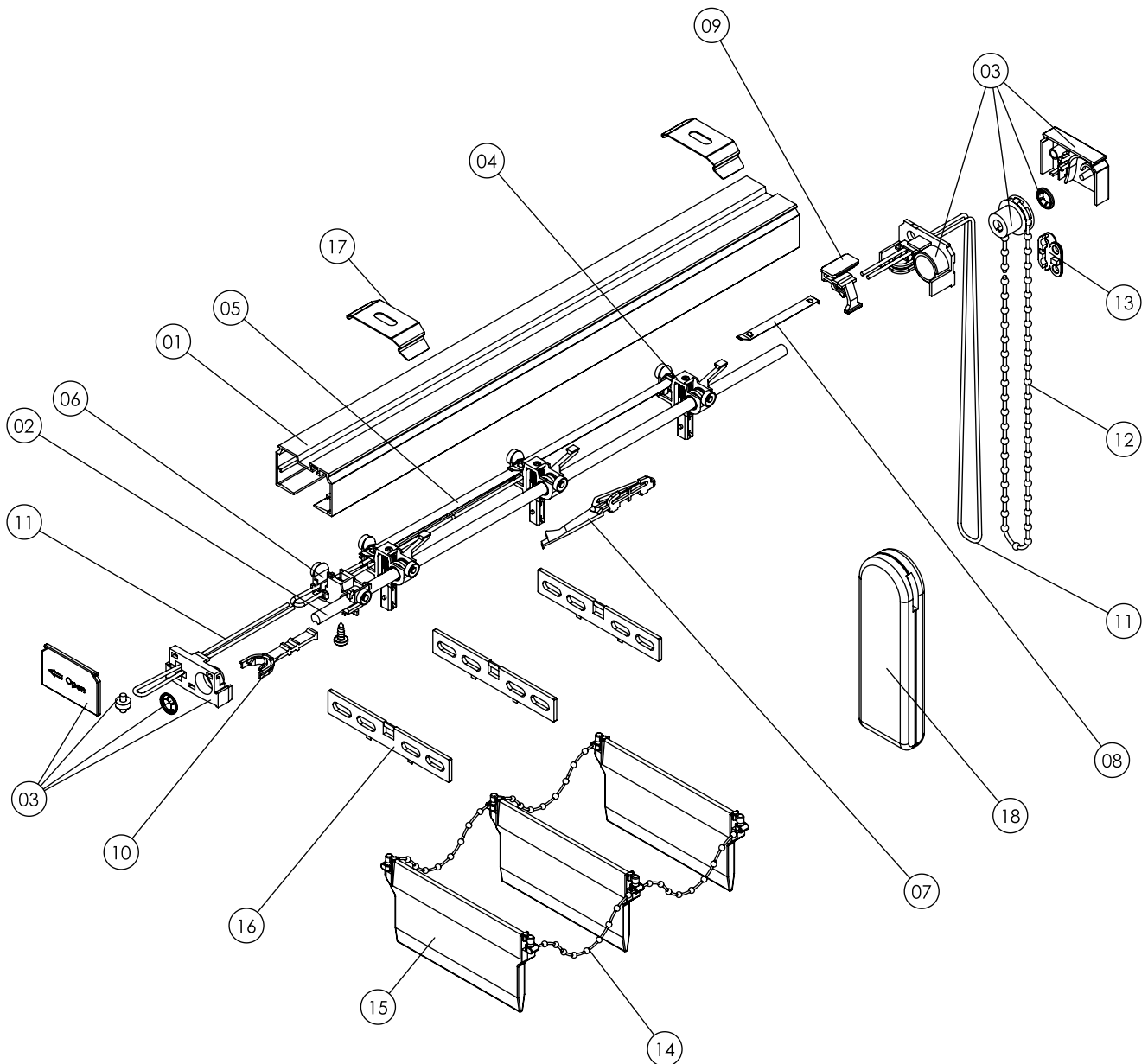

SYSTEM ENIGMA
SYSTEM ENIGMA
SYSTÈME ENIGMA



Abbildung Illustration Illustration	Artikelnr. Article No. Code Article	Artikelbezeichnung Designation Designation	Packeinheit Packing Unit Conditionnement
	3.235.001	ENIGMA-LAUFSCIENE ENIGMA-HEAD RAIL BOÎTIER ENIGMA	70 m 70 m 70 m
	-001	weiß / white / blanc	Längen à 7 m
	-049	schwarz / black / noir	lengths of 7 m
	-058	eloxiert / anodized / anodisé	longueurs de 7 m
	3.235.005.000	NUTWELLE SLOTTED SHAFT AXE À RAINURE	70 m 70 m 70 m
			Längen à 7 m
			lengths of 7 m longueurs de 7 m
	3.235.016	LAUFWAGEN RUNNER CHARIOT	1.134 Stck 1.134 pcs 1.134 pcs
	-001	weiß / white / blanc	
	-010	grau / grey / gris	
	3.235.017	SLOPE-LAUFWAGEN SLOPE RUNNER CHARIOT SLOPE	1.134 Stck 1.134 pcs 1.134 pcs
	-001	weiß / white / blanc	
	-010	grau / grey / gris	
	3.235.036	HAKEN FÜR LAUFWAGEN 3.235.016 XXX HOOK FOR RUNNER 3.235.016 XXX CROCHET POUR CHARIOT 3.235.016 XXX	1.000 Stck 1.000 pcs 1.000 pcs
	-000	transparent / transparent / transparent	
	3.235	SLOPE-HAKEN, transparent SLOPE-HOOK, transparent CROCHET SLOPE, transparent	300 Stck 300 pcs 300 pcs
	-018.000	kurz, short, court	
	-019.000	mittel, medium, moyen	
	-020.000	lang, long, long	
	-034.000	extra lang, extra long, extra long	

Abbildung Illustration Illustration	Artikelnr. Article No. Code Article	Artikelbezeichnung Designation Designation	Packeinheit Packing Unit Conditionnement
	3.235.011	ABSTANDSHALTER EDELSTAHL, 0,22 x 6 mm, für Laufwagen 3.235 016, 3.235 017 LINK SPACER FINE STEEL, 0,22 x 6 mm, for runner 3.235 016, 3.235 017 ECARTEUR ACIER INDOX, 0,22 x 6 mm, pour chariot 3.235 016, 3.235 017	1.000 Stck 1.000 pcs 1.000 pcs
	-030	30 mm Länge / length / longueur	
	-038	38 mm Länge / length / longueur	
	-049	49 mm Länge / length / longueur	
	-071	71 mm Länge / length / longueur	
	-075	75 mm Länge / length / longueur	
	-079	79 mm Länge / length / longueur	
	-083	83 mm Länge / length / longueur	
	-102	102 mm Länge / length / longueur	
	-105	105 mm Länge / length / longueur	
	-108	108 mm Länge / length / longueur	
	-111	111 mm Länge / length / longueur	
-114	114 mm Länge / length / longueur		
-115	115 mm Länge / length / longueur		
	3.235.011	ABSTANDSHALTER EDELSTAHL zum Kürzen, 0,22 x 6 mm, für Laufwagen 3.235 016, 3.235 017 LINK SPACER FINE STEEL for cutting to size, 0,22 x 6 mm, for runner 3.235 016, 3.235 017 ECARTEUR ACIER INDOX à découper, 0,22 x 6 mm, pour chariot 3.235 016, 3.235 017	1.000 Stck 1.000 pcs 1.000 pcs
	-139	139 mm Länge / length / longueur	
	-200	200 mm Länge / length / longueur	
	3.235.012	ENDKAPPEN-SET rechts (1:1) END CAP SET, right (1:1) JEU D'EMBOUTS - droite (1:1)	100 Satz 100 sets 100 jeux
	-001	weiß / white / blanc	
	-010	grau / grey / gris	
	-049	schwarz / black / noir	
	3.235.013	ENDKAPPEN-SET links (1:1) END CAP SET, left (1:1) JEU D'EMBOUTS - gauche (1:1)	100 Satz 100 sets 100 jeux
	-001	weiß / white / blanc	
	-010	grau / grey / gris	
	-049	schwarz / black / noir	

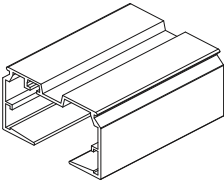
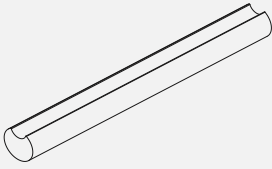
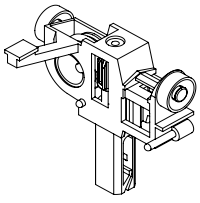
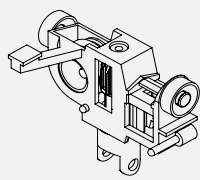
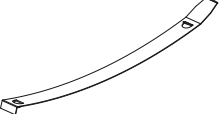
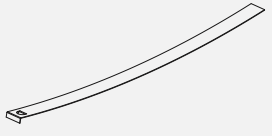
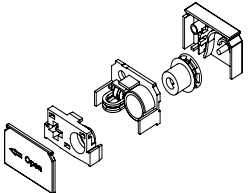
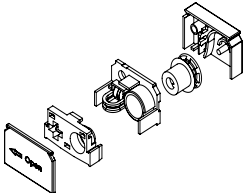
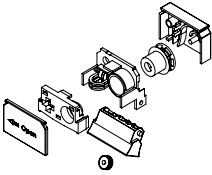

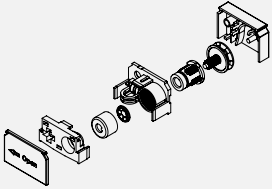
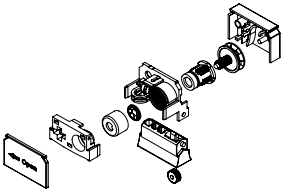
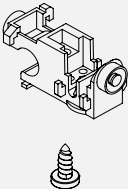
Abbildung Illustration Illustration	Artikelnr. Article No. Code Article	Artikelbezeichnung Designation Designation	Packeinheit Packing Unit Conditionnement
	3.235.014	SLOPE-ENDKAPPEN-SET rechts (1:1) SLOPE END CAP SET, right (1:1) JEU D'EMBOUTS SLOPE - droite (1:1)	40 Satz 40 sets 40 jeux
	-001	weiß / white / blanc	
	-010	grau / grey / gris	
	-049	schwarz / black / noir	
	3.235.015	SLOPE-ENDKAPPEN-SET links (1:1) SLOPE END CAP SET, left (1:1) JEU D'EMBOUTS SLOPE - gauche (1:1)	40 Satz 40 sets 40 jeux
	-001	weiß / white / blanc	
	-010	grau / grey / gris	
	-049	schwarz / black / noir	
	3.235.030	ENDKAPPEN-SET rechts (1:4) END CAP SET, right (1:4) JEU D'EMBOUTS - droite (1:4)	100 Satz 100 sets 100 jeux
	-001	weiß / white / blanc	
	-010	grau / grey / gris	
	3.235.031	ENDKAPPEN-SET links (1:4) END CAP SET, left (1:4) JEU D'EMBOUTS - gauche (1:4)	100 Satz 100 sets 100 jeux
	-001	weiß / white / blanc	
	-010	grau / grey / gris	
	3.235.032	SLOPE-ENDKAPPEN - SET rechts (1:4) SLOPE END CAP SET, right (1:4) JEU D'EMBOUTS SLOPE - droite (1:4)	40 Satz 40 sets 40 jeux
	-001	weiß / white / blanc	
	-010	grau / grey / gris	
	3.235.033	SLOPE-ENDKAPPEN - SET links (1:4) SLOPE END CAP SET, left (1:4) JEU D'EMBOUTS SLOPE - gauche (1:4)	40 Satz 40 sets 40 jeux
	-001	weiß / white / blanc	
	-010	grau / grey / gris	
	3.235.021	SCHNURZUGWAGEN mit Schraube CORD DRIVE RUNNER with screw CHARIOT DE TIRAGE DU CORDON, avec vis	500 Satz 500 sets 500 jeux
	-001	weiß / white / blanc	
	-010	grau / grey / gris	

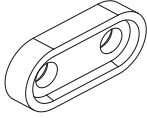
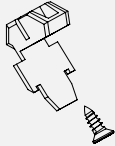
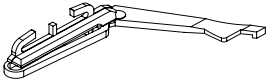
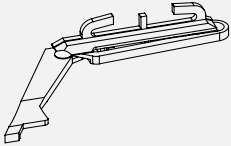
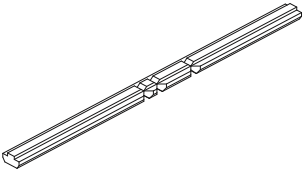
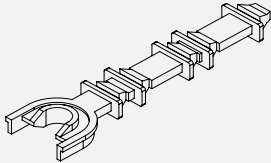
Abbildung Illustration Illustration	Artikelnr. Article No. Code Article	Artikelbezeichnung Designation Designation	Packeinheit Packing Unit Conditionnement
	3.235.029	VERBINDUNGSLASCHE für Schnurzugwagen SPLICE PLATE for cord drive runner LANGUETTE DE RACCORDEMENT pour chariot de tirage du cordon	500 Satz 500 sets 500 jeux
	-001	weiß / white / blanc	
	-010	grau / grey / gris	
	3.235.022	LAUFWAGENSTOPPER mit Paketausrastfunktion RUNNER STOP with bunch release function ARRÊT CHARIOT avec fonction du déclenchement du paquet	150 Satz 150 sets 150 jeux
	-001	weiß / white / blanc	
	-010	grau / grey / gris	
	3.235.023	KLAPPWELLENSTÜTZE rechts HINGED SHAFT SUPPORT, right SUPPORT D'ARBRE, RABATTANT, droite	200 Stck 200 pcs 200 pcs
	-001	weiß / white / blanc	
	-010	grau / grey / gris	
	3.235.024	KLAPPWELLENSTÜTZE links HINGED SHAFT SUPPORT, left SUPPORT D'ARBRE, RABATTANT, gauche	200 Stck 200 pcs 200 pcs
	-001	weiß / white / blanc	
	-010	grau / grey / gris	
	3.235.025.089	DISTANZHALTER, 89 mm DISTANCE HOLDER, 89 mm ECARTEUR, 89 mm	600 Stck 600 pcs 600 pcs
	3.235.025.127	DISTANZHALTER, 127 mm DISTANCE HOLDER, 127 mm ECARTEUR, 127 mm	600 Stck 600 pcs 600 pcs
	3.235.026	PAKETHALTER mit Ausrastfunktion BUNCH HOLDER with release function PORTE PAQUET avec fonction du déclenchement	150 Stck 150 pcs 150 pcs
	-001	weiß / white / blanc	
	-010	grau / grey / gris	
	3.235.027	AUFLAUFSTOPPER END RETAINER ARRÊT FIN DE BOÎTIER	150 Stck 150 pcs 150 pcs
	-001	weiß / white / blanc	
	-010	grau / grey / gris	

Abbildung Illustration Illustration	Artikelnr. Article No. Code Article	Artikelbezeichnung Designation Designation	Packeinheit Packing Unit Conditionnement
	3.233.215.000	FÄCHERFEDER RETAINING WASHER BAGUE DE FIXATION	1.000 Stck 1.000 pcs 1.000 pcs
	3.235.037	PAKETHALTER BUNCH-SPACER ARRÊT DE CHARIOT	100 Stck 100 pcs 100 pcs
	-001	weiß / white / blanc	
	-010	grau / grey / gris	