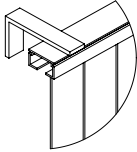
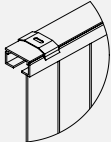
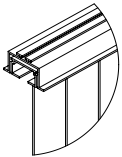
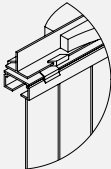
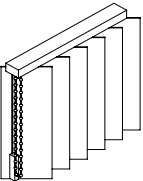
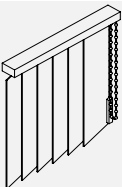
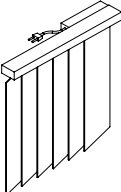
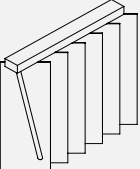
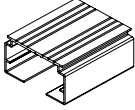
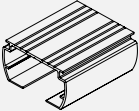
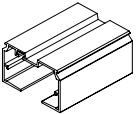
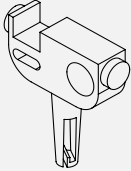
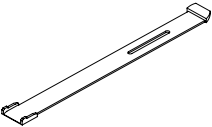
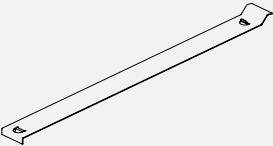

MONTAGE/MOUNTING/MONTAGE

Abbildung Illustration Illustration	Artikelbezeichnung Designation Désignation	Compact/ Omega	Enigma
	WANDMONTAGE WALL-MOUNTED MONTAGE AU MUR	●	●
	DECKENMONTAGE CEILING-MOUNTED MONTAGE AU PLAFOND	●	●
	EINBAUPROFIL INSTALLATION PROFILE PROFILÉ À ENCASTRER	●	●
	SYSTEMDECKE SUSPENDED CEILING PLAFOND SUSPENDUS	●	●
	BEDIENUNG LINKS OPERATION LEFT COMMANDE GAUCHE	●	●
	BEDIENUNG RECHTS OPERATION RIGHT COMMANDE DROITE	●	●
	ELEKTROMOTOR ELECTRICAL MOTOR MOTEUR ELECTRIQUE	●	
	SCHLEUDERSTAB SPIN WAND MANETTE D'ORIENTATION	●	

AUSFÜHRUNGEN/VARIANTS/VARIANTE

Abbildung Illustration Illustration	Artikelbezeichnung Designation Désignation	Compact/ Omega	Enigma
	COMPACT-LAUFSCIENE COMPACT-HEADRAIL BOÎTIER COMPACT	●	
	OMEGA-LAUFSCIENE OMEGA-HEADRAIL BOÎTIER OMEGA	●	
	ENIGMA-LAUFSCIENE ENIGMA-HEADRAIL ENIGMA COMPACT		●
	AUSWECHSELBARER KUNSTSTOFF-HAKEN REPLACEBLE PLATIC HOOK CROCHET PLASTIQUE	●	●
	KUNSTST.-ABSTANDSHALTER PLASTIC SPACER ECARTEUR PLASTIQUE	●	
	STAHL-ABSTANDSHALTER STEEL SPACER ECARTEUR EN MÉTAL	●	●

PAKET/BUNCH/PAQUET

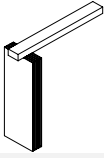
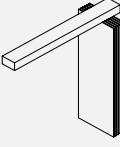
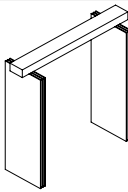
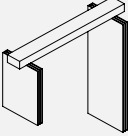
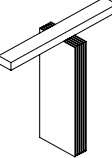
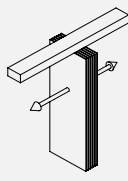
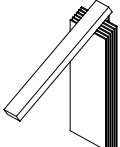
Abbildung Illustration Illustration	Artikelbezeichnung Designation Désignation	Compact/ Omega	Enigma
	PAKET LINKS BUNCH LEFT PAQUET GAUCHE	●	●
	PAKET RECHTS BUNCH RIGHT PAQUET DROITE	●	●
	PAKET LINKS UND RECHTS BUNCH LEFT AND RIGHT PAQUET GAUCHE ET DROITE	●	●
	PAKET LINKS UND RECHTS BUNCH LEFT AND RIGHT PAQUET GAUCHE ET DROITE	●	●
	PAKET MITTIG BUNCH CENTER PAQUET	●	●
	PAKETAUSRÄSTUNG BUNCH RELEASE DÉCLIQUETAGE DU PAQUET	●	●
	SLOPE SLOPE SLOPE	●	●

Nr. No. Code	Artikelnr. Article No. Code Article	Artikelbezeichnung Designation Designation	Nr. No. Code	Artikelnr. Article No. Code Article	Artikelbezeichnung Designation Designation
01	3.233.770.001	Laufschiene / Headrail / Boitier	12	3.233.240.000	Stopping / Stop ring / Bague d'arrêt
02	3.233.671.000	Wendeachse / Tilt shaft / Axe d'orientation	13	3.233.230.000	Sicherungsring / Security ring / Bague de sécurité
03	3.233.201.001	Endkappen-Set / End cap set / Jeu d'Embouts	14	3.233.215.000	Fächerfeder / Retaining washer / Bague de fixation
04	3.234.136.000	Laufwagen / Runner / Chariot	15	3.224.505.001	Zugschnur / Pull cord / Cordon
05	3.233.229.xxx	Abstandshalter / Linkspacer / Ecarteur	16	3.233.227.001	Bedienkette / Operating chain / Chainette de commande
06	3.234.138.000	Schnurzugwagen / Cord drive runner / Chariot de tirage	17	3.232.129.000	Kettenverbinder / Ball chain connector / Joint de chaîne
07	3.233.209.001	Magnethalter / Magnet holder / Support magnétique	18	3.233.226.001	Abstandskette / Bottom chain / Chainette du bas
08	3.233.208.000	Magnetwellenstütze / Magnet shaft support / Support d'arbre	19	3.233.225.001	Beschwerungsplatte / Bottom weight / Plaque de lestage
09	3.233.207.001	Magnetwellenstütze / Magnet shaft support / Support d'arbre	20	3.233.221.090	Lamellenhalter / Slat holder / Support lamelle
10	3.233.220.000	Blindniete / Blind rivet / Rivet	21	3.230.176.001	Montageclip / Fixing clip / Clip de montage
11	3.233.238.xxx	Distanzrohr / Spacer tube / Tube de distance	22	3.230.198.001	Schnur- und Kettembeschwerer / Cord- and chain weight / Poids cordon et chaîne

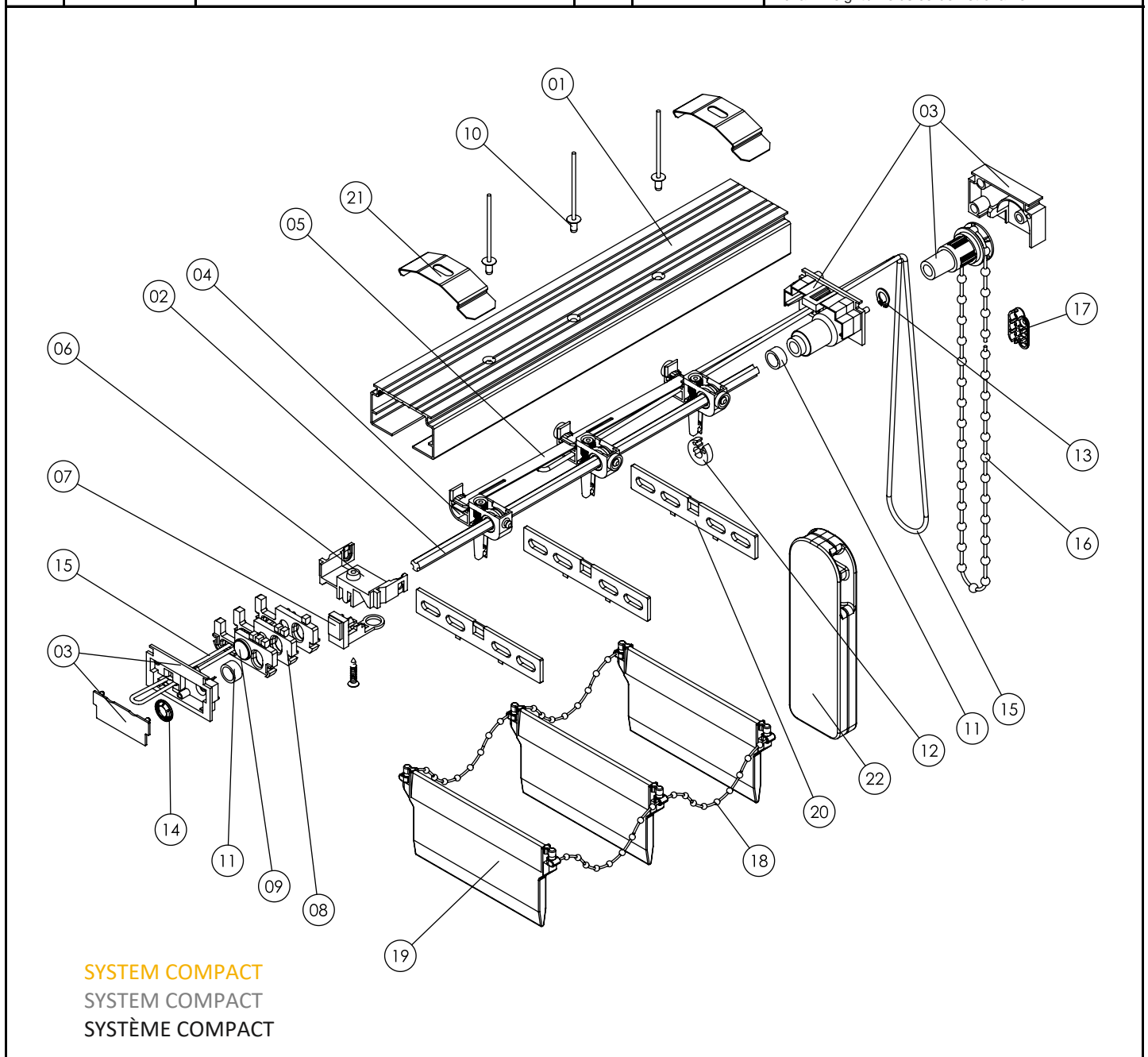

Nr. No. Code	Artikelnr. Article No. Code Article	Artikelbezeichnung Designation Designation	Nr. No. Code	Artikelnr. Article No. Code Article	Artikelbezeichnung Designation Designation
01	3.233.870.001	Laufschiene / Headrail / Boitier	12	3.233.236.000	Paketausrüstung / Bunch release / Déclencheur du paquet
02	3.233.671.000	Wendeachse / Tilt shaft / Axe d'orientation	13	3.233.230.000	Sicherungsring / Security ring / Bague de sécurité
03	3.233.232.001	Endkappen-Set / End cap set / Jeu d'Embouts	14	3.233.215.000	Fächerfeder / Retaining washer / Bague de fixation
04	3.234.135.000	Laufwagen / Runner / Chariot	15	3.224.505.001	Zugschnur / Pull cord / Cordon
05	3.234.156.xxx	Abstandshalter / Link spacer / Ecarteur	16	3.233.227.001	Bedienkette / Operating chain / Chainette de commande
06	3.234.138.000	Schnurzugwagen / Cord drive runner / Chariot de tirage	17	3.232.129.000	Kettenverbinder / Ball chain connector / Joint de chaîne
07	3.233.209.001	Magnethalter / Magnet holder / Support magnétique	18	3.233.226.001	Abstandskette / Bottom chain / Chainette du bas
08	3.233.208.000	Magnetwellenstütze / Magnet shaft support / Support d'arbre	19	3.233.225.001	Beschwerungsplatte / Bottom weight / Plaque de lestage
09	3.233.207.001	Magnetwellenstütze / Magnet shaft support / Support d'arbre	20	3.233.221.090	Lamellenhalter / Slat holder / Support lamelle
10	3.233.220.000	Blindniete / Blind rivet / Rivet	21	3.230.176.001	Montageclip / Fixing clip / Clip de montage
11	3.233.238.xxx	Distanzrohr / Spacer tube / Tube de distance	22	3.230.195.001	Schnurbeschwerer / Cord Weight / Poids de cordon

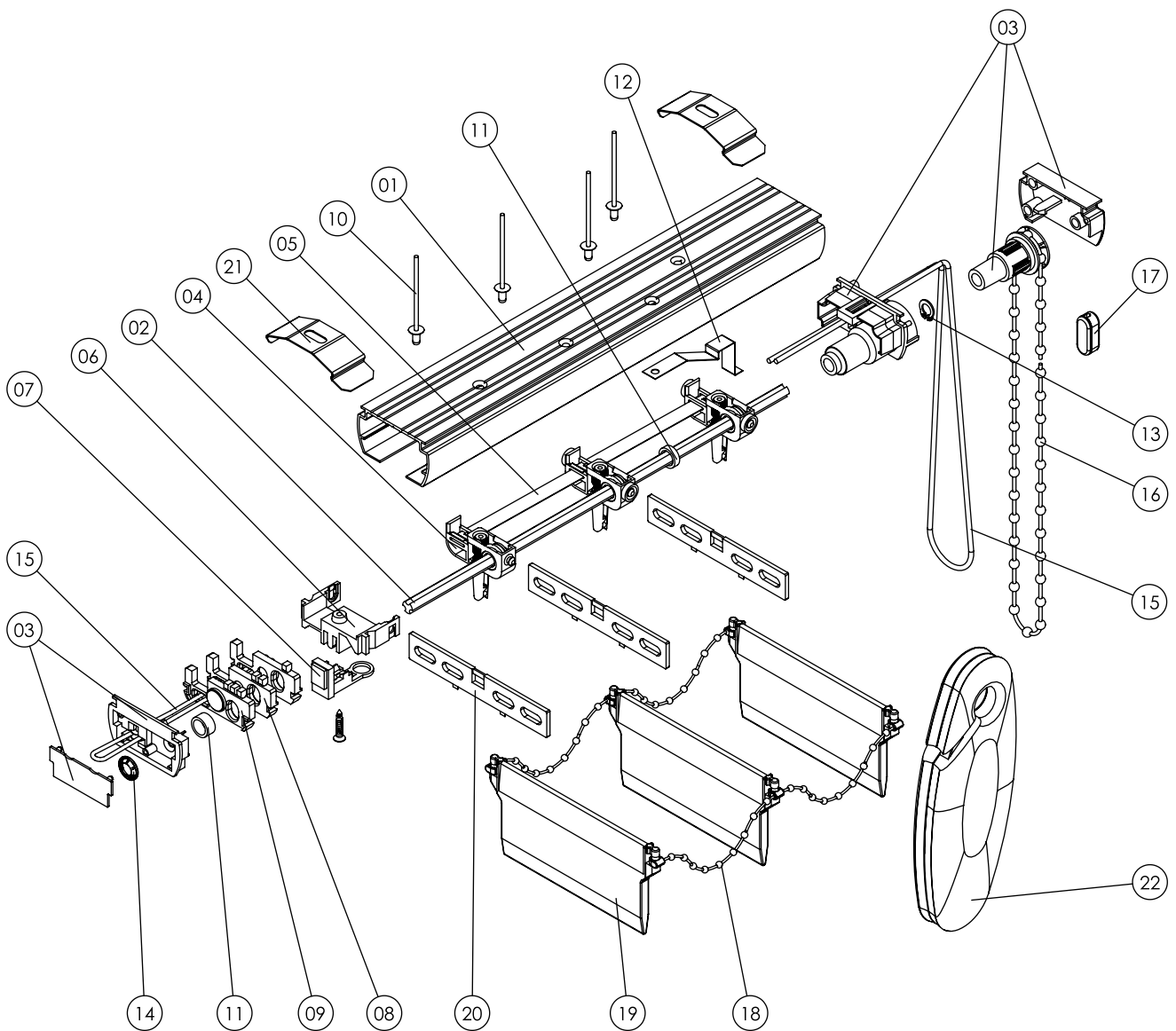

SYSTEM OMEGA
SYSTEM OMEGA
SYSTÈME OMEGA

Abbildung Illustration Illustration	Artikelnr. Article No. Code Article	Artikelbezeichnung Designation Designation	Packeinheit Packing Unit Conditionnement
	3.233.770	COMPACT-LAUFSCIENE, 44,5x25 mm, Aluminium COMPACT-HEADRAIL, 44.5x25 mm, aluminium BOÏTIER COMPACT, 44,5x25 mm, aluminium	70 m 70 m 70 m
	-001	weiß / white / blanc	Längen à 7 m lengths of 7 m longueurs de 7 m
	-058	eloxiert / anodized / anodisé	
	3.233.870	OMEGA-LAUFSCIENE, 44,5x25 mm, Aluminium OMEGA-HEADRAIL, 44.5x25 mm, aluminium BOÏTIER OMEGA, 44,5x25 mm, aluminium	70 m 70 m 70 m
	-001	weiß / white / blanc	Längen à 7 m lengths of 7 m longueurs de 7 m
	-049	schwarz / black / noir	
-058	eloxiert / anodized / anodisé		
	3.233.775	EINBAUPROFIL für Systemdecken INSTALLATION-PROFILE for suspended ceilings PROFILÉ À ENCASTRER pour plafonds suspendus	56 m 56 m 56 m
	-001	weiß / white / blanc	Längen à 7 m lengths of 7 m longueurs de 7 m
	3.233.776	CLIP zur Montage der Laufschiene im Einbauprofil, Kunststoff CLIP for fixing the headrail to the installation profile, plastic CLIP pour montage du rail dans profilé à encastrer, plastique	50 Stck 50 pcs 50 pcs
	-001	weiß / white / blanc	
	3.233.777.000	MONTAGESET FÜR EINBAUPROFIL MOUNTING SET FOR INSTALLATION PROFILE KIT DE MONTAGE POUR PROFILÉ À ENCASTRER	50 Satz 50 sets 50 jeux
	3.233.671.000	WENDEACHSE, Aluminium, 6 mm, 3 Kant TILT SHAFT, aluminium, 6 mm, 3 edged AXE D'ORIENTATION, aluminium, 6 mm, 3 pans	70 m 70 m 70 m
			Längen à 7 m lengths of 7 m longueurs de 7 m
	3.233.670.000	WENDEACHSE, Aluminium, 6 mm, 4 Kant TILT SHAFT, aluminium, 6 mm, 4 edged AXE D'ORIENTATION, aluminium, 6 mm, 4 pans	70 m 70 m 70 m
			Längen à 7 m lengths of 7 m longueurs de 7 m



Abbildung Illustration Illustration	Artikelnr. Article No. Code Article	Artikelbezeichnung Designation Designation	Packeinheit Packing Unit Conditionnement
	3.234.135.000	LAUFWAGEN (9 mm) MIT AUSWECHSELBAREM TRANSPARENTEN KUNSTSTOFFHAKEN für Metallabstandshalter, verwendbar mit 3 und 4kant-Wendeachse RUNNER (9 mm) WITH CHANGEABLE TRANSPARENT PLASTIC HOOK for metal links and for 3 and 4 edged shafts CHARIOT (9 mm) AVEC CROCHET TRANSPARENT, ÉCHANGEABLE, pour écarteur métal et axes d'orientation à 3 et 4 pans	2.000 Stck 2.000 pcs 2.000 pcs
	3.234.136.000	LAUFWAGEN (9 mm) MIT AUSWECHSELBAREM TRANSPARENTEN KUNSTSTOFFHAKEN für Kunststoffabstandshalter, verwendbar mit 3 und 4kant-Wendeachse RUNNER (9 mm) WITH CHANGEABLE TRANSPARENT PLASTIC HOOK for plastic links and for 3 and 4 edged shafts CHARIOT (9 mm) AVEC CROCHET TRANSPARENT, ÉCHANGEABLE, pour écarteur plastique et axes d'orientation à 3 et 4 pans	2.000 Stck 2.000 pcs 2.000 pcs
	3.234.149.000	SLOPE-LAUFWAGEN SLOPE-RUNNER CHARIOT SLOPE	2.000 Stck 2.000 pcs 2.000 pcs
	3.234.137 -000	HAKEN FÜR LAUFWAGEN HOOK FOR RUNNER CROCHET POUR CHARIOT	100 Stck 100 pcs 100 pcs
	3.233 -305.000 -306.000	SLOPE-HAKEN, transparent, mit Kardangelen für Laufwagen 3.234 136 000 und 3.234 140 000 (transparent) SLOPE HOOK, transparent, with cardan joint for runner 3.234 136 000 and 3.234 140 000 (transparent) CROCHET SLOPE, transparent, avec joint de cardan pour chariot 3.234 136 000 et 3.234 140 000 (transparent) kurz / short / court 35° lang / long / long 55°	100 Stck 100 Stck 100 Stck
	3.235 -018.000 -019.000 -020.000 -034.000	SLOPE-HAKEN, transparent, für Laufwagen 3.234.149.000 SLOPE-HOOK, transparent, for runner 3.234.149.000 CROCHET SLOPE, transparent, pour chariot 3.234.149.000 kurz / short / court mittel / medium / moyen lang / long / long extra lang / extra long / extra long	300 Stck 300 pcs 300 pcs

Abbildung Illustration Illustration	Artikelnr. Article No. Code Article	Artikelbezeichnung Designation Designation	Packeinheit Packing Unit Conditionnement
	3.234	SCHNURZUGWAGEN mit Klemmstück und Schraube für Laufwagen 3.234.136.000, 3.234.135.000, 3.230.184.000 und 3.234.149.000 CORD DRIVE RUNNER with clip and screw for carrier 3.234.136.000, 3.234.135.000, 3.230.184.000 and 3.234.149.000 CHARIOT DE TIRAGE DU CORDON avec clip et vis pour chariot 3.234.136.000, 3.234.135.000, 3.230.184.000 et 3.234.149.000	100 Stck 100 Stck 100 Stck
	-138.000	rechts / right / droite	
	-139.000	links / left / gauche	
	3.233	MAGNETHALTER für Schnurzugwagen 3.234.136.000, 3.234.135.000, 3.230.184.000 und 3.234.149.000 MAGNET HOLDER for cord drive runner 3.234.136.000, 3.234.135.000, 3.230.184.000 and 3.234.149.000 SUPPORT MAGNÉTIQUE pour chariot de tirage du cordon 3.234.136.000, 3.234.135.000, 3.230.184.000 et 3.234.149.000	100 Stck 100 Stck 100 Stck
	-209.001	rechts-weiß / right-white / droite-blanc	
	-210.001	links-natur / left-natural / gauche-naturel	
	3.233.207	MAGNETWELLENSTÜTZE, für Laufwagen 3.234.136.000, 3.234.135.000, 3.230.184.000 und 3.234.149.000 MAGNET SHAFT SUPPORT, for carrier 3.234.136.000, 3.234.135.000, 3.230.184.000 and 3.234.149.000 SUPPORT D'ARBRE MAGNÉTIQUE, pour chariot 3.234.136.000, 3.234.135.000, 3.230.184.000 et 3.234.149.000	100 Stck 100 Stck 100 Stck
	-001	rechts-weiß / right-white / droite-blanc	
	3.233.208	MAGNETWELLENSTÜTZE, für Laufwagen 3.234.136.000, 3.234.135.000, 3.230.184.000 und 3.234.149.000 MAGNET SHAFT SUPPORT, for carrier 3.234.136.000, 3.234.135.000, 3.230.184.000 and 3.234.149.000 SUPPORT D'ARBRE MAGNÉTIQUE, pour chariot 3.234.136.000, 3.234.135.000, 3.230.184.000 et 3.234.149.000	100 Stck 100 Stck 100 Stck
	-000	links-natur / left-natural / gauche-naturel	
	3.233.244.000	MITTELSTÜTZE, universal CENTRE SUPPORT, universal SUPPORT CENTRAL, universel	100 Stck 100 pcs 100 pcs
	3.233.307.000	SLOPE WELLENSTÜTZE für Laufwagen 3.234.135.000 und 3.234.149.000 SLOPE SHAFT SUPPORT for carrier for runner 3.234.135.000 and 3.234.149.000 SUPPORT D'ARBRE SLOPE pour chariot 3.234.135.000 et 3.234.149.000	100 Stck 100 pcs 100 pcs

Abbildung Illustration Illustration	Artikelnr. Article No. Code Article	Artikelbezeichnung Designation Designation	Packeinheit Packing Unit Conditionnement
	3.234	LAUFWAGENZUG, bestehend aus 100 Laufwagen 3.234.136.000 und Kunststoffabstandshaltern 3.233.229 XXX RUNNER TRACK, including 100 runners 3.234.136.000 and plastic spacer links 3.233.229 XXX TRAIN DE CHARIOTS, comprenant 100 chariots 3.234.136.000 et écarteurs en plastique 3.233.229 XXX	10 Stck 10 pcs 10 pcs
		-143.073	rechts 73 mm / right 73 mm / droite 73 mm
-144.073		links 73 mm / left 73 mm / gauche 73 mm	
-143.075		rechts 75 mm / right 75 mm / droite 75 mm	
-144.075		links 75 mm / left 75 mm / gauche 75 mm	
-143.078		rechts 78 mm / right 78 mm / droite 78 mm	
-144.078		links 78 mm / left 78 mm / gauche 78 mm	
-143.080		rechts 80 mm / right 80 mm / droite 80 mm	
-144.080		links 80 mm / left 80 mm / gauche 80 mm	
-143.106		rechts 106 mm / right 106 mm / droite 106 mm	
-144.106		links 106 mm / left 106 mm / gauche 106 mm	
-143.110		rechts 110 mm / right 110 mm / droite 110 mm	
-144.110		links 110 mm / left 110 mm / gauche 110 mm	
-143.114		rechts 114 mm / right 114 mm / droite 114 mm	
-144.114	links 114 mm / left 114 mm / gauche 114 mm		
-143.117	rechts 117 mm / right 117 mm / droite 117 mm		
-144.117	links 117 mm / left 117 mm / gauche 117 mm		
	3.233.229	ABSTANDSHALTER, Kunststoff, für Laufwagen 3.234.136.000 LINK SPACER, plastic, for runner 3.234.136.000 ÉCARTEUR, plastique, pour chariot 3.234.136.000	1.000 Stck 1.000 pcs 1.000 pcs
	-073	73 mm Länge / length / longueur	
	-075	75 mm Länge / length / longueur	
	-078	78 mm Länge / length / longueur	
	-080	80 mm Länge / length / longueur	
	-106	106 mm Länge / length / longueur	
	-110	110 mm Länge / length / longueur	
	-114	114 mm Länge / length / longueur	
	-117	117 mm Länge / length / longueur	
		3.230.186	ABSTANDSHALTER EDELSTAHL zum Kürzen, 0,22 x 8 mm für Laufwagen 3.234.135.000, 3.234.149.000, 3.230.184.000 LINK SPACER FINE STEEL for cutting to size, 0,22 x 8 mm for runner 3.234.135.000, 3.234.149.000, 3.230.184.000 ÉCARTEUR ACIER INOXYDABLE à découper, 0,22 x 8 mm pour chariot 3.234.135.000, 3.234.149.000, 3.230.184.000
-139		139 mm Länge / length / longueur	
-200		200 mm Länge / length / longueur	

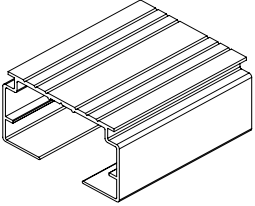
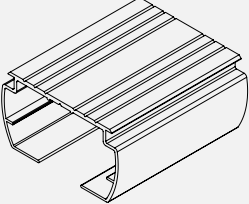
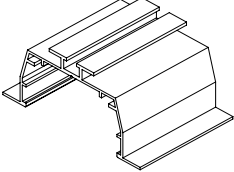
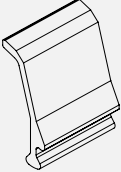
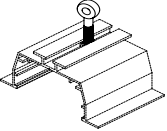
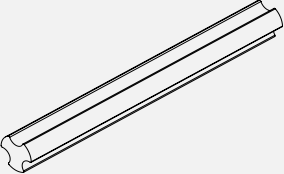
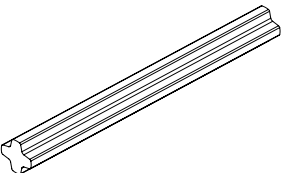

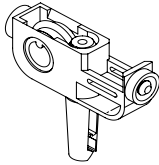
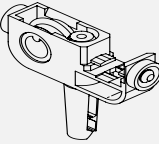
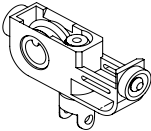
Abbildung Illustration Illustration	Artikelnr. Article No. Code Article	Artikelbezeichnung Designation Designation	Packeinheit Packing Unit Conditionnement	
	3.234.156	ABSTANDSHALTER EDELSTAHL, 0,22 x 8 mm für Laufwagen 3.234.135.000 und 3.230.184.000 LINK SPACER FINE STEEL, 0,22 x 8 mm for runner 3.234.135.000 and 3.230.184.000 ÉCARTEUR ACIER INOXYDABLE, 0,22 x 8 mm pour chariot 3.234.135.000 et 3.230.184.000	1.000 Stck 1.000 pcs 1.000 pcs	
	-070	70 mm Länge / length / longueur		
	-071	71 mm Länge / length / longueur		
	-072	72 mm Länge / length / longueur		
	-073	73 mm Länge / length / longueur		
	-074	74 mm Länge / length / longueur		
	-075	75 mm Länge / length / longueur		
	-076	76 mm Länge / length / longueur		
	-077	77 mm Länge / length / longueur		
	-078	78 mm Länge / length / longueur		
	-079	79 mm Länge / length / longueur		
	-080	80 mm Länge / length / longueur		
	-101	101 mm Länge / length / longueur		
	-102	102 mm Länge / length / longueur		
	-103	103 mm Länge / length / longueur		
	-104	104 mm Länge / length / longueur		
	-105	105 mm Länge / length / longueur		
	-106	106 mm Länge / length / longueur		
	-107	107 mm Länge / length / longueur		
-108	108 mm Länge / length / longueur			
-109	109 mm Länge / length / longueur			
-110	110 mm Länge / length / longueur			
-111	111 mm Länge / length / longueur			
-112	112 mm Länge / length / longueur			
-113	113 mm Länge / length / longueur			
-114	114 mm Länge / length / longueur			
-115	115 mm Länge / length / longueur			
-116	116 mm Länge / length / longueur			
-117	117 mm Länge / length / longueur			
	3.234.141.200	ABSTANDSHALTER EDELSTAHL, für Slope, 0,3 mm, 200 mm, für Laufwagen 3.234.136.000 und in Verbindung mit Schuh 3.234.141.000 LINK SPACER FINE STEEL, for Slope, 0.3 mm, 200 mm, for runner 3.234.136.000 and to be combined with base 3.234.141.000 ÉCARTEUR ACIER INOXYDABLE, pour Slope, 0,3 mm, 200 mm, pour chariot 3.234.136.000 et à combiner avec coussinet 3.234.141.000	1.000 Stck 1.000 pcs 1.000 pcs	
		3.234.141.000	SCHUH FÜR STAHLABSTANDSHALTER 3.234 141 200 BASE FOR STEEL LINK 3.234 141 200 COUSSINET POUR ÉCARTEUR EN ACIER 3.234 141 200	1.000 Stck 1.000 pcs 1.000 pcs
	3.234.157	ABSTANDSHALTER EDELSTAHL zum Kürzen, 0,22x8 mm, für Laufwagen 3.234.149.000 LINK SPACER FINE STEEL for cutting to Size, 0,22x8 mm, for runner 3.234.149.000 ÉCARTEUR ACIER SURFIN à découper sur mesure, 0,22x8 mm, pour chariot 3.234.149.000	1.000 Stck 1.000 pcs 1.000 pcs	
	-200	200 mm Länge / 200 mm length / 200 mm longueur		

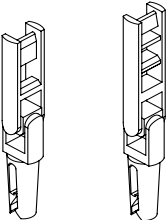
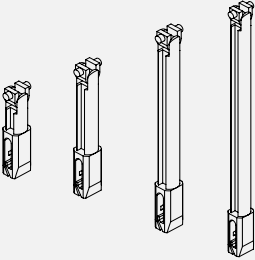
Abbildung Illustration Illustration	Artikelnr. Article No. Code Article	Artikelbezeichnung Designation Designation	Packeinheit Packing Unit Conditionnement
	3.233.	ENDKAPPEN-SET, AS/NS, Compact END CAP SET, OPERATING / NON-OPERATING END, Compact JEU D'EMBOUITS, CÔTÉ COMMANDE / NON-COMMANDE, Compact	250 satz 250 sets 250 jeux
	-201.001	rechts-weiß / right-white / droite-blanc	
	-202.001	links-weiß / left-white / gauche-blanc	
	-201.010	rechts-grau right-grey / droite-gris	
	-202.010	links-grau / left-grey / gauche-gris	
	3.233	ENDKAPPEN-SET, AS/NS, Omega END CAP SET, OPERATING / NON-OPERATING END, Omega JEU D'EMBOUITS, CÔTÉ COMMANDE / NON-COMMANDE, Omega	250 satz 250 sets 250 jeux
	-232.001	rechts-weiß / right-white / droite-blanc	
	-231.001	links-weiß / left-white / gauche-blanc	
	-232.010	rechts-grau right-grey / droite-gris	
	-231.010	links-grau / left-grey / gauche-gris	
	3.233	SLOPE ENDKAPPEN-SET, Compact SLOPE END CAP SET, Compact JEU D'EMBOUITS SLOPE, Compact	50 Satz 50 sets 50 jeux
	-303.001	rechts-weiß / right-white / droite-blanc	
	-303.010	rechts-grau / right-grey / droite-gris	
	-304.001	links-weiß / left-white / gauche-blanc	
	-304.010	links-grau / left-grey / gauche-gris	
	3.233	SLOPE ENDKAPPEN-SET, Omega SLOPE END CAP SET, Omega JEU D'EMBOUITS SLOPE, Omega	50 Satz 50 sets 50 jeux
	-234.001	links-weiß / left-white / gauche-blanc	
	-235.001	rechts-weiß / right-white / droite-blanc	
	-234.010	links-grau / left-grey / gauche-gris	
	-235.010	rechts-grau / right-grey / droite-gris	
	3.233.300.000	SCHRAUBEN-SET FÜR SLOPE-ENDKAPPEN-SET Compact und Omega SCREW SET FOR SLOPE END CAP SET Compact and Omega JEU DE VIS POUR JEU D'EMBOUITS SLOPE Compact et Omega	50 Satz 50 sets 50 jeux

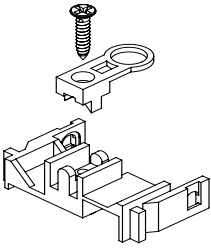
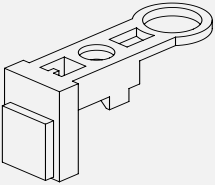
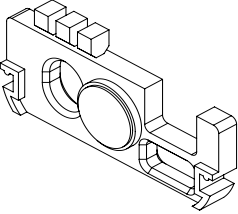
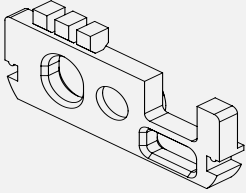
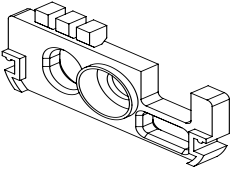
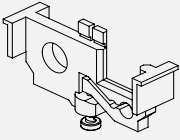

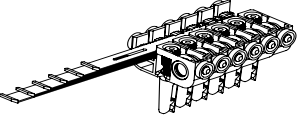
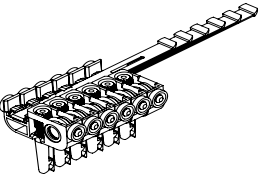
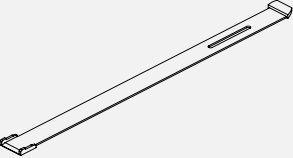
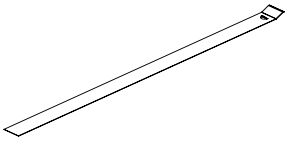

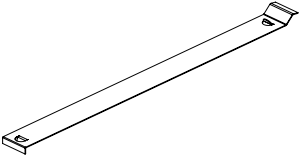

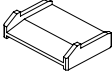
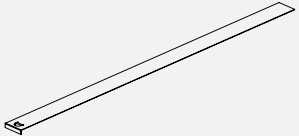
Abbildung Illustration Illustration	Artikelnr. Article No. Code Article	Artikelbezeichnung Designation Designation	Packeinheit Packing Unit Conditionnement
	3.233.236.000	PAKETAUSRÄSTUNG AUS NIROSTA für Laufwagen 3.234.136.000, 3.234.135.000 und 3.230.184.000	100 Stck
		BUNCH RELEASE, STAINLESS STEEL for runner 3.234.136.000, 3.234.135.000 and 3.230.184.00	100 pcs
		DÉCLENCHEUR DU PAQUET, EN ACIER INOX pour chariot 3.234.136.000, 3.234.135.000 et 3.230.184.000	100 pcs
	3.233.238	DISTANZROHR SPACER TUBE TUBE DE DISTANCE	500 Stck 500 pcs 500 pcs
	-003	3 mm Länge / length / longueur	
	-005	5 mm Länge / length / longueur	
	-009	9 mm Länge / length / longueur	
	-021	21 mm Länge / length / longueur	
	-025	25 mm Länge / length / longueur	
-051	51 mm Länge / length / longueur		
	3.233.214.000	STOPPRING, Kunststoff STOP RING, plastic BAGUE D'ARRÊT, plastique	2.000 Stck 2.000 pcs 2.000 pcs
	3.233.240.000	STOPPRING MIT AUGEN, Kunststoff STOP RING WITH EYES, plastic BAGUE D'ARRÊT AVEC OEUILLETES, plastique	5.000 Stck 5.000 pcs 5.000 pcs
	3.233.218.000	STELLRING mit Gewindestift, Metall SET COLLAR with threaded pin, metal BAGUE DE RÉGLAGE avec tige filetée, métal	100 Stck 100 pcs 100 pcs
	3.233.215.000	FÄCHERFEDER, 6 mm, NS RETAINING WASHER, 6 mm, non operating end BAGUE DE FIXATION, 6 mm, coté non-commande	1.000 Stck 1.000 pcs 1.000 pcs
	3.233.246.000	FÄCHERFEDER, 6 mm, AS RETAINING WASHER, 6 mm, operating end BAGUE DE FIXATION, 6 mm, coté commande	1.000 Stck 1.000 pcs 1.000 pcs
	3.233.230.000	SICHERUNGSRING, AS, Metall SECURITY RING, operating side, metal BAGUE DE SECURITÉ, coté commande, métal	1.000 Stck 1.000 pcs 1.000 pcs
	3.233.216.000	WELLENSTIFT, Slope SHAFT PIN, Slope TIGE POUR ARBRE, Slope	100 Stck 100 pcs 100 pcs

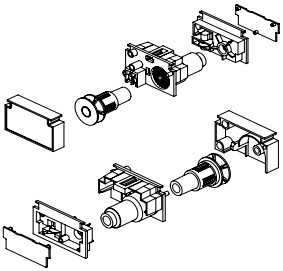
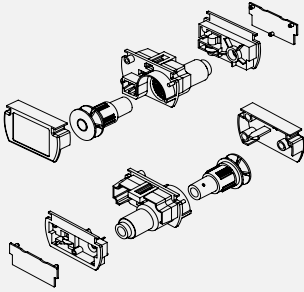
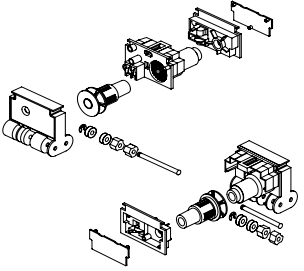
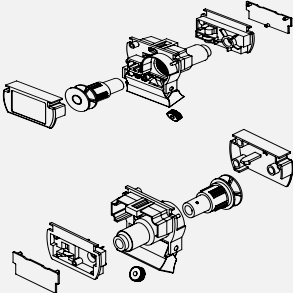
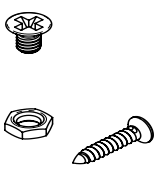
Abbildung Illustration Illustration	Artikelnr. Article No. Code Article	Artikelbezeichnung Designation Designation	Packeinheit Packing Unit Conditionnement
	3.233.219.000	BLINDNIETE für Slope Wellenstütze, 3 x 6 mm BLIND RIVET for Slope shaft support, 3 x 6 mm RIVET AVEUGLE pour support d'arbre Slope, 3 x 6 mm	100 Stck 100 pcs 100 pcs
	3.233.220.000	SENKKOPF-BLINDNIETE für Magnetwellenstütze 3,2 x 6 mm COUNTERSUNK BLIND RIVET for magnet shaft support 3,2 x 6 mm RIVET AVEUGLE À TÊTE CONIQUE pour support d'arbre magnétique 3,2 x 6 mm	1.000 Stck 1.000 pcs 1.000 pcs
	3.002.000.121	BLINDNIETE für Magnetwellenstütze 3x5 mm COUNTERSUNK BLIND RIVET for magnet shaft support 3x5 mm RIVET AVEUGLE À TÊTE CONIQUE pour support d'arbre magnétique 3x5 mm	1.000 Stck 1.000 pcs 1.000 pcs
	3.233.252	SCHLEUDERSTABGETRIEBE SPIN WAND GEAR UNIT ENGRENAGE POUR MANETTE D'ORIENTATION	100 Stck 100 pcs 100 pcs
	-001	weiß / white / blanc	
	3.233.253	SCHLEUDERSTAB 1.500 mm SPIN WAND 1.500 mm MANETTE D'ORIENTATION 1.500 mm	100 Stck 100 pcs 100 pcs
	-001	weiß / white / blanc	
	3.230.220	SCHIENENVERBINDER SET, OMEGA RAIL CONNECTOR SET, OMEGA JEU DE CONNECTEURS DE RAIL, OMEGA	10 Satz 10 sets 10 jeux
	-001	weiß / white / blanc	
	-011	grau / grey / gris	
	-049	schwarz / black / noir	
	3.230.221	SCHIENENVERBINDER SET, Compact RAIL CONNECTOR SET, Compact JEU DE CONNECTEURS DE RAIL, Compact	10 Satz 10 sets 10 jeux
	-001	weiß / white / blanc	
	-011	grau / grey / gris	

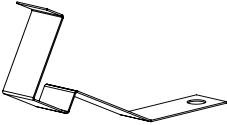
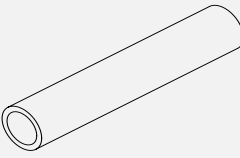
Nr. No. Code	Artikelnr. Article No. Code Article	Artikelbezeichnung Designation Designation	Nr. No. Code	Artikelnr. Article No. Code Article	Artikelbezeichnung Designation Designation
01	3.233.770.001	Laufschiene / Headrail / Boitier	10	3.233.220.000	Blindniete / Blind rivet / Rivet
02	3.233.671.000	Wendeachse / Tilt shaft / Axe d'orientation	11	3.233.238.xxx	Distanzrohr / Spacer tube / Tube de distance
03	3.233.903.001	Elektromotor / Electrical motor / Moteur électrique	12	3.233.240.000	Stoppring / Stop ring / Bague d'arrêt
04	3.234.136.000	Laufwagen / Runner / Chariot	13	3.233.200.001	Endkappen-Set / End cap set / Jeu d'Embouts
05	3.233.229.xxx	Abstandshalter / Link spacer / Ecarteur	14	3.233.215.000	Fächerfeder / Retaining washer / Bague de fixation
06	3.234.139.000	Schnurzugwagen / Cord drive runner / Chariot de tirage	15	3.224.005.001	Antriebskette / Drive chain / Chaîne de transmission
07	3.233.210.000	Magnethalter / Magnet holder / Support magnétique	16	3.233.226.001	Abstandskette / Bottom chain / Chaîn de transmission
08	3.233.207.001	Magnetwellenstütze / Magnet shaft support / Support d'arbre	17	3.233.225.001	Beschwerungsplatte / Bottom weight / Plaque de lestage
09	3.233.208.000	Magnetwellenstütze / Magnet shaft support / Support d'arbre	18	3.233.221.090	Lamellenhalter / Slat holder / Support lamelle
			19	3.230.176.001	Montageclip / Fixing clip / Clip de montage

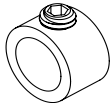
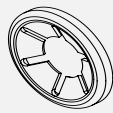

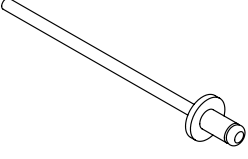
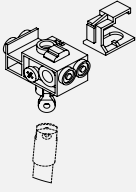
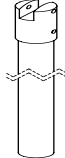
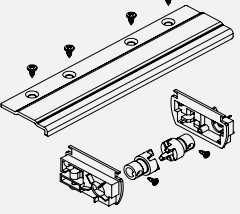
ELEKTRO KOMPONENTEN
ELECTRICAL COMPONENTS
ÉLÉMENTS DE MOTORISATION

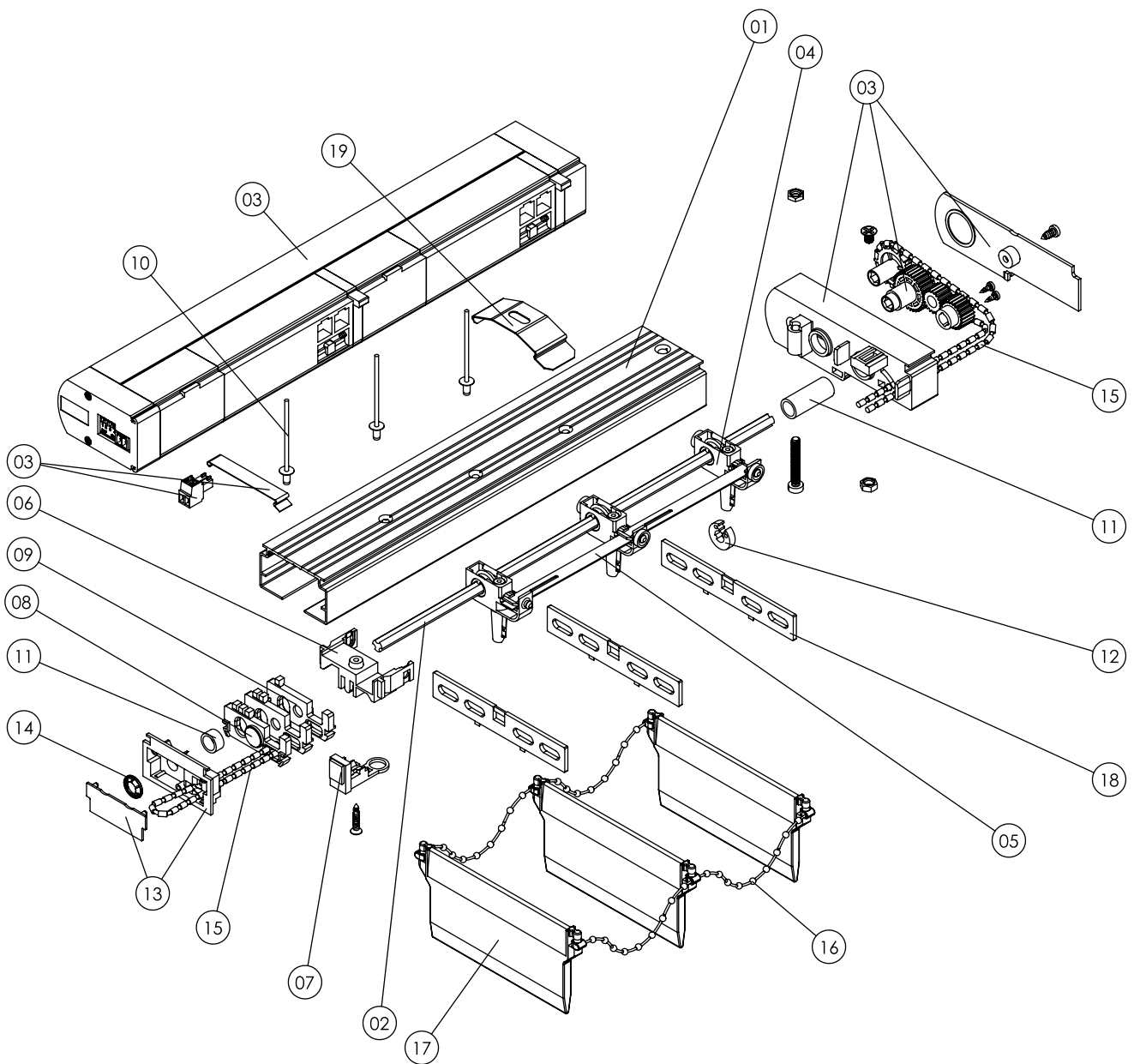



Abbildung Illustration Illustration	Artikelnr. Article No. Code Article	Artikelbezeichnung Designation Designation	Packeinheit Packing Unit Conditionnement
	3.224.005.001	ANTRIEBSKETTE FÜR VERTIKALMOTOR, weiß DRIVE CHAIN FOR MOTOR VERTICAL BLIND, white CHAÎNE DE TRANSMISSION POUR MOTEUR STORES, blanc	250 m 250 m 250 m
	3.233 -903.001 -904.001	ENDKAPPEN-SET NS, für Elektromotor END CAP SET NON OPERATING END, for electrical motor JEU D'EMBOUS, CÔTÉ NON-COMMANDE, pour moteur électrique links, weiß / left, white / gauche, blanc rechts, weiß / right, white / droite, blanc	1 Stck 1 pce 1 pce
	3.233 -199.001 -200.001	ENDKAPPEN-SET NS, für Elektromotor END CAP SET NON OPERATING END, for electrical motor JEU D'EMBOUS, CÔTÉ NON-COMMANDE, pour moteur électrique links, weiß / left, white / gauche, blanc rechts, weiß / right, white / droite, blanc	10 Satz 10 sets 10 jeux
	3.233 -195.001 -196.001	OMEGA ENDKAPPEN-SET NS, für Elektromotor OMEGA ENDCAP SET NON OPERATING END, for electrical Motor OMEGA JEU D'EMBOUS, COTÉ NON COMMAND, pour moteur électrique links, weiß / left, white / gauche, blanc rechts, weiß / right, white / droite, blanc	10 Satz 10 sets 10 jeux
	3.233.955.001	Steckernetzteil 230V AC/24V DC 1 A für max. 2 Antriebe, weiß Plug-in power supply 230V AC/24V DC 1 A for max. 2 units, white Alimentation enfichable 230V AC/24V DC 1 A pour 2 unités max., blanc	1 Stck 1 pcs 1 pcs
	3.233.931.000	SCHALTERNETZTEIL Inis DC Rollo (Somfy 1 870 071) für 1 Anlage, weiß POWER SUPPLY with built-in switch, Inis DC roller, for 1 unit, white ALIMENTATION avec interrupteur intégré, Inis DC roller, pour 1 unité, blanc	1 Stck 1 pcs 1 pcs
	3.233.930.001	inteo AUFPUTZKAPPE (Somfy 9 102 004), weiß inteo SURFACE MOUNTING BOX "Ines DC roller", white BOÎTIER EN SAILLIE "Inteo" gris, "Ines DC roller", blanc	1 Stck 1 pcs 1 pcs
	3.233.933.000	FUNK-HANDESENDER 1-KANAL "Telis RTS 1" (Somfy 1 810 630), weiß RADIO REMOTE CONTROL TRANSMITTER "Telis 1 RTS", white TÉLÉCOMMANDE "Telis 1 RTS", blanc	1 Stck 1 pcs 1 pcs
	3.233.934.000	FUNK-HANDESENDER 5-KANAL "Telis 5 RTS" (Somfy 1 810 631), weiß RADIO REMOTE CONTROL TRANSMITTER "Telis 5 RTS", white TÉLÉCOMMANDE "Telis 5 RTS", blanc	1 Stck 1 pcs 1 pcs

Abbildung Illustration Illustration	Artikelnr. Article No. Code Article	Artikelbezeichnung Designation Designation	Packeinheit Packing Unit Conditionnement
	3.233.954.000	FUNK-HANDESENDER mit Scrollrad 5-Kanal Telis 5 RTS Pure (Somfy 1 810 765)	1 Stck
		RADIO-CONTROL, with scroll wheel, control 5-channel Telis 5 RTS Pure (Somfy 1810765)	1 pcs
		TÉLÉCOMMANDE, avec bouton de roulette, Telis 5 pour variation RTS Pure (Somfy 1 810 974)	1 pcs
	3.233.932.000	FUNKEMPFÄNGER, für max. 2 Anlagen, "Modul DC RTS" (Somfy 1 870 016), weiß	1 Stck
		RADIO RECEIVER, for max 2. units "modul DC RTS", white	1 pcs
		RÉCEPTEUR "MODULE DC RTS", pour max 2 stores, blanc	1 pcs

Weiterhin ist ein umfangreiches Steuerungszubehör wie Gruppensteuerungen, Sonnenautomatik etc. von Somfy erhältlich

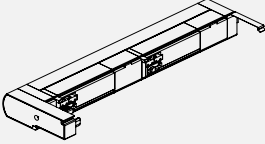
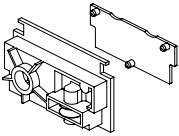
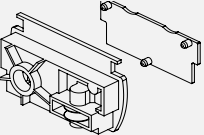
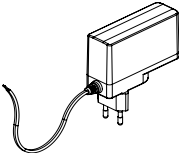
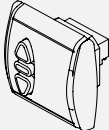
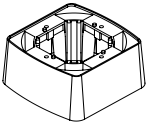
A wide range of control accessories such as group controls, automatic sun control, etc. are also available from Somfy

Une large gamme d'accessoires de régulation tels que les commandes groupées, le contrôle solaire automatique, etc. sont également disponibles chez Somfy

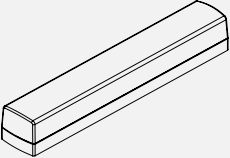
Nr. No. Code	Artikelnr. Article No. Code Article	Artikelbezeichnung Designation Designation	Nr. No. Code	Artikelnr. Article No. Code Article	Artikelbezeichnung Designation Designation
01	3.235.001.001	Laufschiene / Headrail / Boitier	11	3.235.028.001	Zugschnur / Pull cord / Cordon
02	3.235.005.000	Nutwelle / Slotted shaft / Axe à rainure	12	3.224.003.001	Bedienkette / Operating chain / Chainette de commande
03	3.235.012.001	Endkappen-Set / End cap set / Jeu d'Embouts	13	3.232.129.000	Kettenverbinder / Ball chain connector / Joint de chaîne
04	3.235.016.001	Laufwagen / Runner / Chariot	14	3.233.226.001	Abstandskette / Bottom chain / Chainette du bas
05	3.235.011.xxx	Abstandshalter / Link spacer / Écarteur	15	3.233.225.001	Beschwerungsplatte / Bottom weight / Plaque de lestage
06	3.235.021.001	Schnurzugwagen / Cord drive runner / Chariot de tirage	16	3.233.221.090	Lamellenhalter / Slat holder / Support lamelle
07	3.235.023.001	Klappwellenstütze / Shaft support / Support d'arbre	17	3.230.185.001	Montageclip / Fixing clip / Clip de montage
08	3.235.011.030	Abstandshalter / Link spacer / Ecarteur	18	3.230.174.001	Schnurbeschwerer / Cord weight / Poids de cordon
09	3.235.037.001	Beweglicher Pakethalter / Moveable bunch-spacer / Porte-paquet mobile			
10	3.235.027.001	Auflaufstopper / End retainer / Arrêt fin de boîtier			

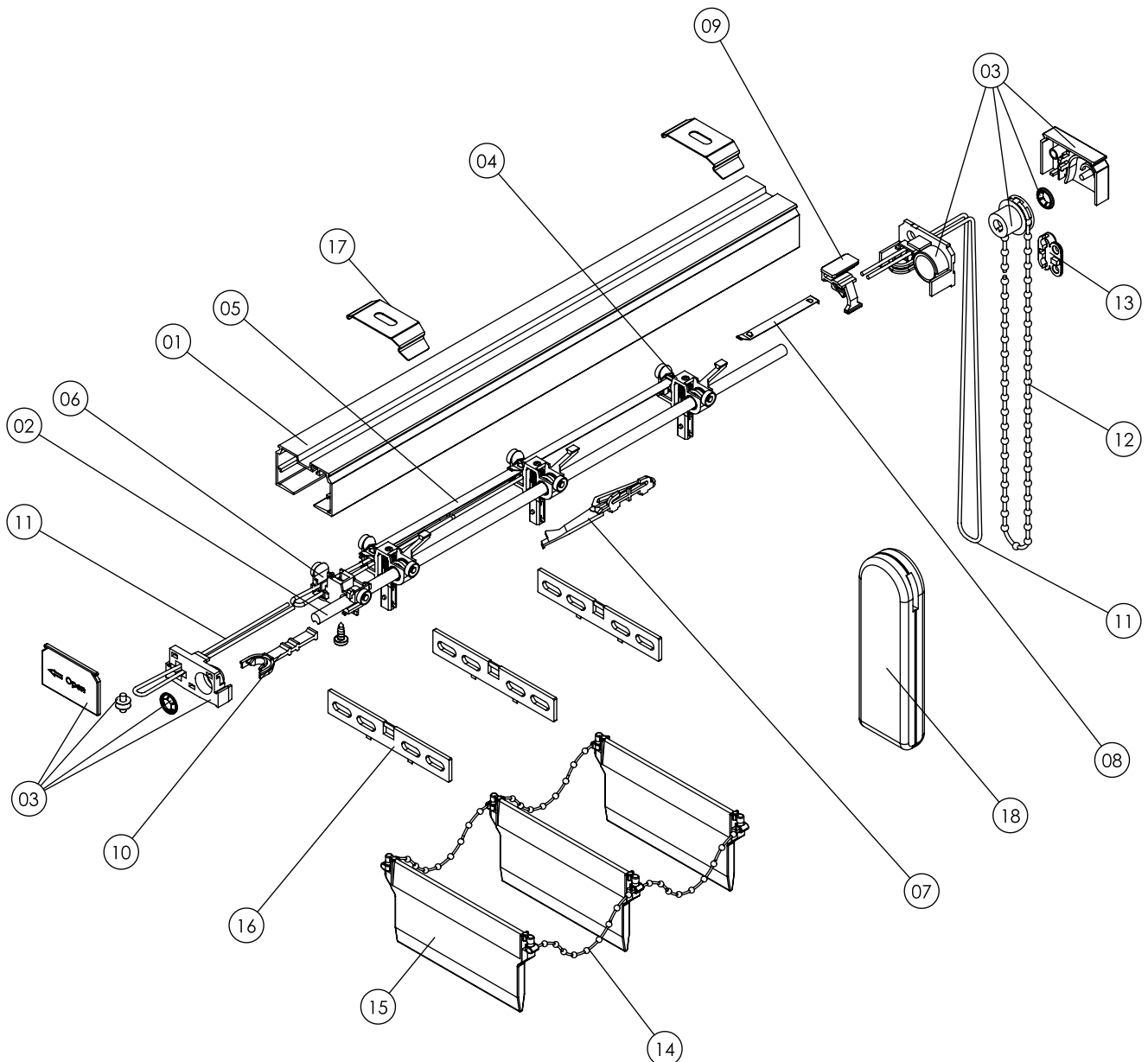

SYSTEM ENIGMA
SYSTEM ENIGMA
SYSTÈME ENIGMA



Abbildung Illustration Illustration	Artikelnr. Article No. Code Article	Artikelbezeichnung Designation Designation	Packeinheit Packing Unit Conditionnement
	3.235.001	ENIGMA-LAUFSCIENE ENIGMA-HEAD RAIL BOÎTIER ENIGMA	70 m 70 m 70 m
	-001	weiß / white / blanc	Längen à 7 m
	-049	schwarz / black / noir	lengths of 7 m
	-058	eloxiert / anodized / anodisé	longueurs de 7 m
	3.235.005.000	NUTWELLE SLOTTED SHAFT AXE À RAINURE	70 m 70 m 70 m
			Längen à 7 m
			lengths of 7 m longueurs de 7 m
	3.235.016	LAUFWAGEN RUNNER CHARIOT	1.134 Stck 1.134 pcs 1.134 pcs
	-001	weiß / white / blanc	
	-010	grau / grey / gris	
	3.235.017	SLOPE-LAUFWAGEN SLOPE RUNNER CHARIOT SLOPE	1.134 Stck 1.134 pcs 1.134 pcs
	-001	weiß / white / blanc	
	-010	grau / grey / gris	
	3.235.036	HAKEN FÜR LAUFWAGEN 3.235.016 XXX HOOK FOR RUNNER 3.235.016 XXX CROCHET POUR CHARIOT 3.235.016 XXX	1.000 Stck 1.000 pcs 1.000 pcs
	-000	transparent / transparent / transparent	
	3.235	SLOPE-HAKEN, transparent SLOPE-HOOK, transparent CROCHET SLOPE, transparent	300 Stck 300 pcs 300 pcs
	-018.000	kurz, short, court	
	-019.000	mittel, medium, moyen	
	-020.000	lang, long, long	
	-034.000	extra lang, extra long, extra long	

Abbildung Illustration Illustration	Artikelnr. Article No. Code Article	Artikelbezeichnung Designation Designation	Packeinheit Packing Unit Conditionnement
	3.235.011	ABSTANDSHALTER EDELSTAHL, 0,22 x 6 mm, für Laufwagen 3.235 016, 3.235 017 LINK SPACER FINE STEEL, 0,22 x 6 mm, for runner 3.235 016, 3.235 017 ECARTEUR ACIER INDOX, 0,22 x 6 mm, pour chariot 3.235 016, 3.235 017	1.000 Stck 1.000 pcs 1.000 pcs
	-030	30 mm Länge / length / longueur	
	-038	38 mm Länge / length / longueur	
	-049	49 mm Länge / length / longueur	
	-071	71 mm Länge / length / longueur	
	-075	75 mm Länge / length / longueur	
	-079	79 mm Länge / length / longueur	
	-083	83 mm Länge / length / longueur	
	-102	102 mm Länge / length / longueur	
	-105	105 mm Länge / length / longueur	
	-108	108 mm Länge / length / longueur	
	-111	111 mm Länge / length / longueur	
-114	114 mm Länge / length / longueur		
-115	115 mm Länge / length / longueur		
	3.235.011	ABSTANDSHALTER EDELSTAHL zum Kürzen, 0,22 x 6 mm, für Laufwagen 3.235 016, 3.235 017 LINK SPACER FINE STEEL for cutting to size, 0,22 x 6 mm, for runner 3.235 016, 3.235 017 ECARTEUR ACIER INDOX à découper, 0,22 x 6 mm, pour chariot 3.235 016, 3.235 017	1.000 Stck 1.000 pcs 1.000 pcs
	-139	139 mm Länge / length / longueur	
	-200	200 mm Länge / length / longueur	
	3.235.012	ENDKAPPEN-SET rechts (1:1) END CAP SET, right (1:1) JEU D'EMBOUTS - droite (1:1)	100 Satz 100 sets 100 jeux
	-001	weiß / white / blanc	
	-010	grau / grey / gris	
	-049	schwarz / black / noir	
	3.235.013	ENDKAPPEN-SET links (1:1) END CAP SET, left (1:1) JEU D'EMBOUTS - gauche (1:1)	100 Satz 100 sets 100 jeux
	-001	weiß / white / blanc	
	-010	grau / grey / gris	
	-049	schwarz / black / noir	

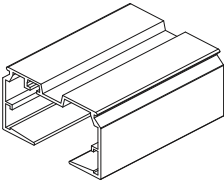
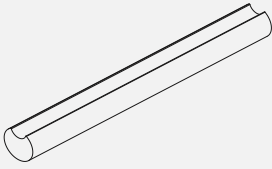
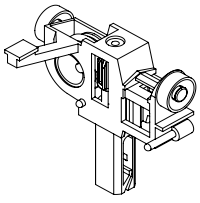
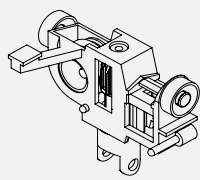

Abbildung Illustration Illustration	Artikelnr. Article No. Code Article	Artikelbezeichnung Designation Designation	Packeinheit Packing Unit Conditionnement
	3.235.014	SLOPE-ENDKAPPEN-SET rechts (1:1) SLOPE END CAP SET, right (1:1) JEU D'EMBOUTS SLOPE - droite (1:1)	40 Satz 40 sets 40 jeux
	-001	weiß / white / blanc	
	-010	grau / grey / gris	
	-049	schwarz / black / noir	
	3.235.015	SLOPE-ENDKAPPEN-SET links (1:1) SLOPE END CAP SET, left (1:1) JEU D'EMBOUTS SLOPE - gauche (1:1)	40 Satz 40 sets 40 jeux
	-001	weiß / white / blanc	
	-010	grau / grey / gris	
	-049	schwarz / black / noir	
	3.235.030	ENDKAPPEN-SET rechts (1:4) END CAP SET, right (1:4) JEU D'EMBOUTS - droite (1:4)	100 Satz 100 sets 100 jeux
	-001	weiß / white / blanc	
	-010	grau / grey / gris	
	3.235.031	ENDKAPPEN-SET links (1:4) END CAP SET, left (1:4) JEU D'EMBOUTS - gauche (1:4)	100 Satz 100 sets 100 jeux
	-001	weiß / white / blanc	
	-010	grau / grey / gris	
	3.235.032	SLOPE-ENDKAPPEN - SET rechts (1:4) SLOPE END CAP SET, right (1:4) JEU D'EMBOUTS SLOPE - droite (1:4)	40 Satz 40 sets 40 jeux
	-001	weiß / white / blanc	
	-010	grau / grey / gris	
	3.235.033	SLOPE-ENDKAPPEN - SET links (1:4) SLOPE END CAP SET, left (1:4) JEU D'EMBOUTS SLOPE - gauche (1:4)	40 Satz 40 sets 40 jeux
	-001	weiß / white / blanc	
	-010	grau / grey / gris	
	3.235.021	SCHNURZUGWAGEN mit Schraube CORD DRIVE RUNNER with screw CHARIOT DE TIRAGE DU CORDON, avec vis	500 Satz 500 sets 500 jeux
	-001	weiß / white / blanc	
	-010	grau / grey / gris	

Abbildung Illustration Illustration	Artikelnr. Article No. Code Article	Artikelbezeichnung Designation Designation	Packeinheit Packing Unit Conditionnement
	3.235.029	VERBINDUNGSLASCHE für Schnurzugwagen SPLICE PLATE for cord drive runner LANGUETTE DE RACCORDEMENT pour chariot de tirage du cordon	500 Satz 500 sets 500 jeux
	-001	weiß / white / blanc	
	-010	grau / grey / gris	
	3.235.022	LAUFWAGENSTOPPER mit Paketausrastfunktion RUNNER STOP with bunch release function ARRÊT CHARIOT avec fonction du déclenchement du paquet	150 Satz 150 sets 150 jeux
	-001	weiß / white / blanc	
	-010	grau / grey / gris	
	3.235.023	KLAPPWELLENSTÜTZE rechts HINGED SHAFT SUPPORT, right SUPPORT D'ARBRE, RABATTANT, droite	200 Stck 200 pcs 200 pcs
	-001	weiß / white / blanc	
	-010	grau / grey / gris	
	3.235.024	KLAPPWELLENSTÜTZE links HINGED SHAFT SUPPORT, left SUPPORT D'ARBRE, RABATTANT, gauche	200 Stck 200 pcs 200 pcs
	-001	weiß / white / blanc	
	-010	grau / grey / gris	
	3.235.025.089	DISTANZHALTER, 89 mm DISTANCE HOLDER, 89 mm ECARTEUR, 89 mm	600 Stck 600 pcs 600 pcs
	3.235.025.127	DISTANZHALTER, 127 mm DISTANCE HOLDER, 127 mm ECARTEUR, 127 mm	600 Stck 600 pcs 600 pcs
	3.235.026	PAKETHALTER mit Ausrastfunktion BUNCH HOLDER with release function PORTE PAQUET avec fonction du déclenchement	150 Stck 150 pcs 150 pcs
	-001	weiß / white / blanc	
	-010	grau / grey / gris	
	3.235.027	AUFLAUFSTOPPER END RETAINER ARRÊT FIN DE BOÎTIER	150 Stck 150 pcs 150 pcs
	-001	weiß / white / blanc	
	-010	grau / grey / gris	

Abbildung Illustration Illustration	Artikelnr. Article No. Code Article	Artikelbezeichnung Designation Designation	Packeinheit Packing Unit Conditionnement
	3.233.215.000	FÄCHERFEDER RETAINING WASHER BAGUE DE FIXATION	1.000 Stck 1.000 pcs 1.000 pcs
	3.235.037	PAKETHALTER BUNCH-SPACER ARRÊT DE CHARIOT	100 Stck 100 pcs 100 pcs
	-001	weiß / white / blanc	
	-010	grau / grey / gris	

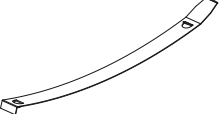
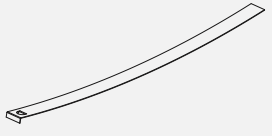
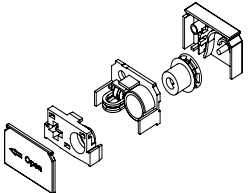
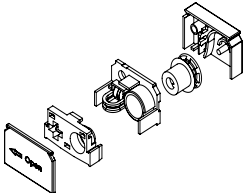
Abbildung Illustration Illustration	Artikelnr. Article No. Code Article	Artikelbezeichnung Designation Designation	Packeinheit Packing Unit Conditionnement
	3.230.176	MONTAGECLIP für 45 mm Schiene FIXING CLIP for head rail 40 mm CLIP DE MONTAGE pour boîtier 45 mm	1.000 Stck 1.000 pcs 1.000 pcs
	-000	natur / natural / naturel	
	-001	weiß / white / blanc	
	-049	schwarz / black / noir	
	3.230.185	MONTAGECLIP für 40 mm Schiene FIXING CLIP for head rail 40 mm CLIP DE MONTAGE pour boîtier 40 mm	1.000 Stck 1.000 pcs 1.000 pcs
	-000	natur / natural / naturel	
	-001	weiß / white / blanc	
	-049	schwarz / black / noir	
	3.230.206	SCHNELLMONTAGECLIP für Systemschienen (24 mm und 15 mm) QUICK FITTING CLIP for rail systems (24 mm and 15 mm) CLIP DE MONTAGE RAPIDE pour systèmes de rail (24 mm et 15 mm)	100 Stck 100 pcs 100 pcs
	-001	weiß / white / blanc	
	3.230.207	SCHNELLMONTAGECLIP mit Clip (45 mm) QUICK FITTING CLIP with Clip (45 mm) CLIP DE MONTAGE RAPIDE avec clip (45 mm)	100 Stck 100 pcs 100 pcs
	-001	weiß / white / blanc	
	3.230.208	SCHNELLMONTAGECLIP mit Clip (40 mm) QUICK FITTING CLIP with Clip (40 mm) CLIP DE MONTAGE RAPIDE avec clip (40 mm)	100 Stck 100 pcs 100 pcs
	-001	weiß / white / blanc	
	3.230.209	SCHNELLMONTAGECLIP mit Clip (45 mm) und Distanzstück (7 mm) QUICK FITTING CLIP with Clip (45 mm) and spacer (7 mm) CLIP DE MONTAGE RAPIDE avec clip (45 mm) et ÉCARTEUR (7 mm)	100 Stck 100 pcs 100 pcs
	-001	weiß / white / blanc	
	3.230.210	SCHNELLMONTAGECLIP mit Clip (40 mm) und Distanzstück (7 mm) QUICK FITTING CLIP with Clip (40 mm) and spacer (7 mm) CLIP DE MONTAGE RAPIDE avec clip (40 mm) et ÉCARTEUR (7 mm)	100 Stck 100 pcs 100 pcs
	-001	weiß / white / blanc	

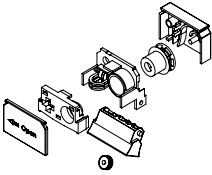
Abbildung Illustration Illustration	Artikelnr. Article No. Code Article	Artikelbezeichnung Designation Designation	Packeinheit Packing Unit Conditionnement
	3.230.292	VERLÄNGERUNGSWINKEL, Nutzlänge: 65 – 100 mm EXTENSION BRACKET, usable length: 65 – 100 mm EQUERRE EXTENSIBLE, longueur utile: 65 – 100 mm	100 Stck 100 pcs 100 pcs
	-000	verzinkt / galvanized / zingué	
	-001	weiß / white / blanc	
	-049	schwarz / black / noir	
	-060	braun / brown / brun	
	3.430.292	VERLÄNGERUNGSWINKEL (65 - 100 mm) mit Clip (3.230.176) für Vertikalschiene 45 mm EXTENSION BRACKET (65 - 100 mm) with Clip (3.230.176) for head rail 45 mm EQUERRE EXTENSIBLE (65 - 100 mm) avec clip (3.230.176) pour boîtier 45 mm	100 Stck 100 pcs 100 pcs
	-000	verzinkt / galvanized / zingué	
	-001	weiß / white / blanc	
	-049	schwarz / black / noir	
	3.431.292	VERLÄNGERUNGSWINKEL (65 - 100 mm) mit Clip (3.230.185) für Vertikalschiene 40 mm EXTENSION BRACKET (65 - 100 mm) with Clip (3.230.185) for head rail 40 mm EQUERRE EXTENSIBLE (65 - 100 mm) avec clip (3.230.185) pour boîtier 40 mm	100 Stck 100 pcs 100 pcs
	-000	verzinkt / galvanized / zingué	
	-001	weiß / white / blanc	
	-049	schwarz / black / noir	
	3.230.293	VERLÄNGERUNGSWINKEL mit Kunststoffschiebemutter 3.141.050 und Schraube, Nutzlänge: 100 – 150 mm EXTENSION BRACKET with plastic nut 3.141.050 and screw, usable length: 100 – 150 mm EQUERRE EXTENSIBLE avec écrou en plastique 3.141.050 et vis, longueur utile: 100 – 150 mm	100 Stck 100 pcs 100 pcs
	-000	verzinkt / galvanized / zingué	
	-001	weiß / white / blanc	
	-010	grau / grey / gris	
	-049	schwarz / black / noir	
	-060	braun / brown / brun	
	-111	elfenbein / ivory / ivoire	

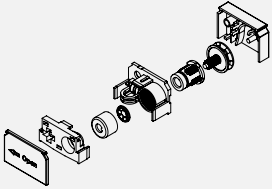
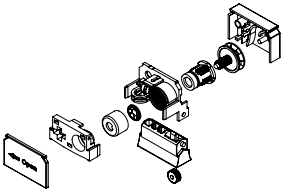
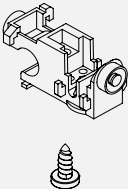
Abbildung Illustration Illustration	Artikelnr. Article No. Code Article	Artikelbezeichnung Designation Designation	Packeinheit Packing Unit Conditionnement
	3.430.293	VERLÄNGERUNGSWINKEL (100 - 150 mm) mit Clip (3.230.176) für Vertikalschiene 45 mm, mit Metallgewindeplatte (3.100.142.000) mit Schraube EXTENSION BRACKET (100 - 150 mm) with Clip (3.230.176) for head rail 45 mm, with metal plate with thread (3.100.142.000) and screw EQUERRE EXTENSIBLE (100 - 150 mm) avec clip (3.230.176) pour boîtier 45 mm, avec platine en métal avec filetage (3.100.142.000) et vis	50 Stck 50 pcs 50 pcs
	-000	verzinkt / galvanized / zingué	
	-001	weiß / white / blanc	
	-049	schwarz / black / noir	
	3.431.293	VERLÄNGERUNGSWINKEL (100 - 150 mm) mit Clip (3.230.185) für Vertikalschiene 40 mm, mit Metallgewindeplatte (3.100.142.000) mit Schraube EXTENSION BRACKET (100 - 150 mm) with Clip (3.230.185) for head rail 40 mm, with metal plate with thread (3.100.142.000) and screw EQUERRE EXTENSIBLE (100 - 150 mm) avec clip (3.230.185) pour boîtier 40 mm, avec platine en métal avec filetage (3.100.142.000) et vis	50 Stck 50 pcs 50 pcs
	-000	verzinkt / galvanized / zingué	
	-001	weiß / white / blanc	
	-049	schwarz / black / noir	
	3.230.294	VERLÄNGERUNGSWINKEL mit Kunststoffschiebemutter 3.141.050 und Schraube, Nutzlänge: 150 – 250 mm EXTENSION BRACKET with plastic nut 3.141.050 and screw, usable length: 150 – 250 mm EQUERRE EXTENSIBLE avec écrou en plastique 3.141.050 et vis, longueur utile: 150 – 250 mm	30 Stck 30 pcs 30 pcs
	-000	verzinkt / galvanized / zingué	
	-001	weiß / white / blanc	
	-010	grau / grey / gris	
	-049	schwarz / black / noir	
	-060	braun / brown / brun	
-111	elfenbein / ivory / ivoire		
	3.430.294	VERLÄNGERUNGSWINKEL (150 - 250 mm) mit Clip (3.230.176) für Vertikalschiene 45 mm, mit Metallgewindeplatte (3.100.142.000) mit Schraube EXTENSION BRACKET (150 - 250 mm) with Clip (3.230.176) for head rail 45 mm, with metal plate with thread (3.100.142.000) and screw EQUERRE EXTENSIBLE (150 - 250 mm) avec clip (3.230.176) pour boîtier 45 mm, avec platine en métal avec filetage (3.100.142.000) et vis	30 Stck 30 pcs 30 pcs
	-000	verzinkt / galvanized / zingué	
	-001	weiß / white / blanc	
	-049	schwarz / black / noir	

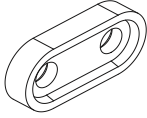
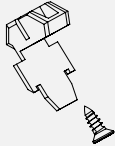
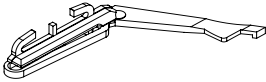
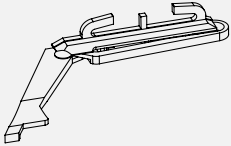
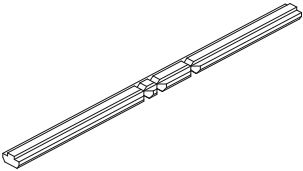
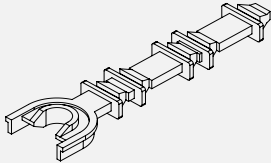
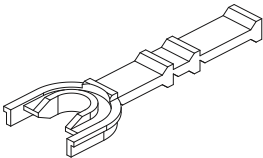
Abbildung Illustration Illustration	Artikelnr. Article No. Code Article	Artikelbezeichnung Designation Designation	Packeinheit Packing Unit Conditionnement	
	3.431.294	VERLÄNGERUNGSWINKEL (150 - 250 mm) mit Clip (3.230.185) für Vertikalschiene 40 mm, mit Metallgewindeplatte (3.100.142.000) mit Schraube EXTENSION BRACKET (150 - 250 mm) with Clip (3.230.185) for head rail 40 mm, with metal plate with thread (3.100.142.000) and screw EQUERRE EXTENSIBLE (150 - 250 mm) avec clip (3.230.185) pour boîtier 40 mm, avec platine en métal avec filetage (3.100.142.000) et vis	30 Stck 30 pcs 30 pcs	
	-000	verzinkt / galvanized / zingué		
	-001	weiß / white / blanc		
	-049	schwarz / black / noir		
	3.230.297	ABDECKKAPPE, Kunststoff, für Verlängerungswinkel 3.230.293 und 3.230.294 BRACKET COVER, plastic, for extension bracket no. 3.230.293 and 3.230.294 ENJOLIVEUR, matière plastique, pour équerre extensible no. 3.230.293 et 3.230.294	50 Stck 50 pcs 50 pcs	
	-001	weiß / white / blanc		
	-010	grau / grey / gris		
	-049	schwarz / black / noir		
	-060	braun / brown / brun		
-111	elfenbein / ivory / ivoire			
	3.100.142.000	METALLGEWINDEPLATTE 11,4 x 14 mm, mit M4-Gewinde für Verlängerungswinkel 3.230.293 und 3.230.294 METAL PLATE 11,4 x 14 mm, with tread M4 for extension brackets 3.230.293 and 3.230.294 PLATINE EN MÉTAL 11,4 X 14 mm, avec filetage M4 pour équerres extensibles 3.230.293 et 3.230.294	100 Stck 100 pcs 100 pcs	
		3.002.000	BEFESTIGUNGSSCHRAUBE FIXING SCREW VIS DE FIXATION	100 Stck 100 pcs 100 pcs
		-068	M4 x 6	
		-031	M4 x 8	
-082	M4 x 10			

Abbildung Illustration Illustration	Artikelnr. Article No. Code Article	Artikelbezeichnung Designation Designation	Packeinheit Packing Unit Conditionnement
	3.233.221	LAMELLENHALTER, Kunststoff, transparent SLAT HOLDER, plastic, transparent SUPPORT LAMELLES, matière plastique, transparent	1.000 Stck 1.000 pcs 1.000 pcs
	-090 -127	90 mm Länge / length / longueur 127 mm Länge / length / longueur	
	3.233.222	S-LAMELLENHALTER, Kunststoff, transparent S-SLAT HOLDER, plastic, transparent S-SUPPORT LAMELLES, matière plastique, transparent	1.000 Stck 1.000 pcs 1.000 pcs
	-090 -127	90 mm Länge / length / longueur 127 mm Länge / length / longueur	
	3.233.221	LAMELLENHALTER, Kunststoff, weiß SLAT HOLDER, plastic, white SUPPORT LAMELLES, matière plastique, blanc	1.000 Stck 1.000 pcs 1.000 pcs
	-250	250 mm Länge / length / longueur	
	3.233	VOLLKUNSTSTOFF BESCHWERUNGSPLATTE SOLID PLASTIC BOTTOM WEIGHT PLAQUE DE LESTAGE, PLEIN PLASTIQUE	100 Stck 100 pcs 100 pcs
	-223.001	63 mm, weiß / white / blanc	
	-225.001	90 mm, weiß / white / blanc	
	-225.010	90 mm, grau / grey / gris	
	-225.049	90 mm, schwarz / black / noir	
	-224.001	127 mm, weiß / white / blanc	
	-224.010 -224.049	127 mm, grau / grey / gris 127 mm, schwarz / black / noir	
	3.233.242	BESCHWERUNGSPLATTE, zum Einhängen (ohne Kette) BOTTOM WEIGHT, to be hung in (without chain) PLAQUE DE LESTAGE, à accrocher (sans chaînette)	250 Stck 250 pcs 250 pcs
	-90 -127	90 mm, weiß / white / blanc 127 mm, weiß / white / blanc	
	3.233.243.107	BESCHWERUNGSPLATTE 107 mm, zum Einschweißen in 127 mm Lamellen BOTTOM WEIGHT 107 mm, for welding into 127 mm slats PLAQUE DE LESTAGE 107 mm, à souder dans lamelles de 127 mm	250 Stck 250 pcs 250 pcs
	3.233.242	BESCHWERUNGSPLATTE, zum Einhängen (ohne Kette) BOTTOM WEIGHT, to be hung in (without chain) PLAQUE DE LESTAGE, à accrocher (sans chaînette)	100 Stck 100 pcs 100 pcs
	-250	250 mm, weiß / white / blanc	

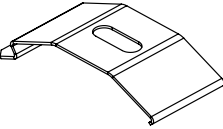
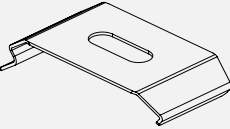
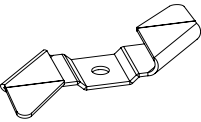
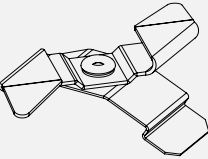
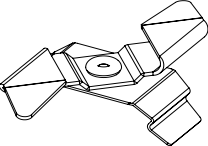
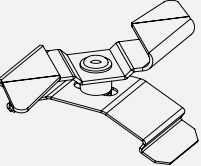
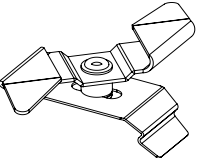

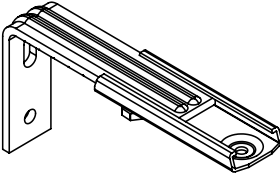
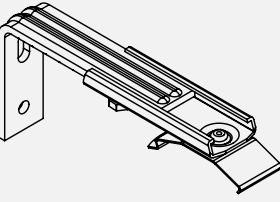
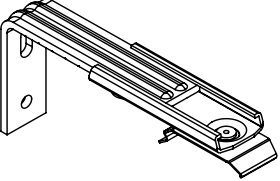
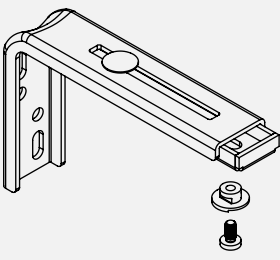

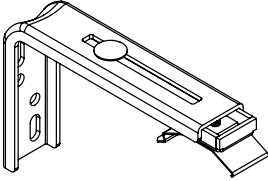
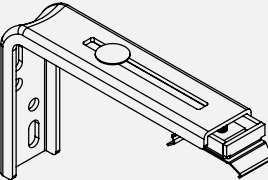
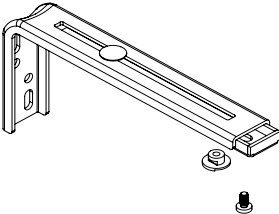
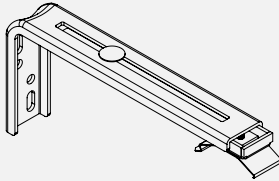
Abbildung Illustration Illustration	Artikelnr. Article No. Code Article	Artikelbezeichnung Designation Designation	Packeinheit Packing Unit Conditionnement
	3.233.226	ABSTANDSKETTE für 90 mm Lamelle BOTTOM CHAIN for 90 mm louvre CHAÎNETTE DU BAS pour 90 mm lamelle	250 m 250 m 250 m
	-001	100 mm, weiß / white / blanc	
	-010	100 mm, grau / grey / gris	
	-049	100 mm, schwarz / black / noir	
	3.239.226	ABSTANDSKETTE Metall für 90 mm Lamelle BOTTOM CHAIN metal for 90 mm louvre CHAÎNETTE DU BAS métal pour 90 mm lamelle	150 m 150 m 150 m
	-000	100 mm, metall / metal / métal	
		ABSTANDSKETTE für 127 mm Lamelle BOTTOM CHAIN for 127 mm louvre CHAÎNETTE DU BAS pour 127 mm lamelle	250 m 250 m 250 m
	-001	120 mm, weiß / white / blanc	
	-010	120 mm, grau / grey / gris	
	-049	120 mm, schwarz / black / noir	
	3.233.239 -001	130 mm, weiß / white / blanc	
	-010	130 mm, grau / grey / gris	
	3.239.239	ABSTANDSKETTE Metall für 127 mm Lamelle BOTTOM CHAIN metal for 127 mm louvre CHAÎNETTE DU BAS métal pour 127 mm lamelle	150 m 150 m 150 m
	-000	130 mm, metall / metal / métal	
	3.233.227	BEDIENKETTE, Kugel ø 4,5 mm, Kugelabstand 12 mm OPERATING CHAIN, ball ø 4.5 mm, distance between balls 12 mm CHAÎNETTE DE COMMANDE, boule ø 4,5 mm, distance des boules 12 mm	250 m 250 m 250 m
	-000	transparent / transparent / transparent	
	-001	weiß / white / blanc	
	-010	grau / grey / gris	
	-049	schwarz / black / noir	
	3.224.003	BEDIENKETTE, Kugel ø 3,8 mm, Kugelabstand 9,1 mm OPERATING CHAIN, ball ø 3.8 mm, distance between balls 9.1 mm CHAÎNETTE DE COMMANDE, boule ø 3,8 mm, distance des boules 9,1 mm	250 m 250 m 250 m
	-001	weiß / white / blanc	
	-010	grau / grey / gris	
	-049	schwarz / black / noir	
	3.232.129	KETTENVERBINDER für Bedienkette mit Kugel ø 4,5 mm und 3,8 mm BALL CHAIN CONNECTOR for ball chain ø 4,5 mm and 3,8 mm JOINT DE CHAÎNE pour chaîne à boules ø 4,5 mm et 3,8 mm	500 Stck 500 pcs 500 pcs
	-000	transparent / transparent / transparent	
	-001	weiß / white / blanc	
	-010	grau / grey / gris	
	-049	schwarz / black / noir	

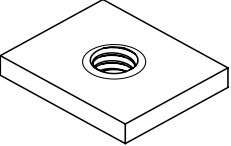
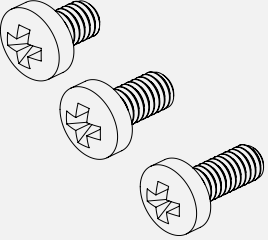
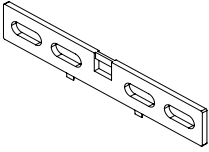
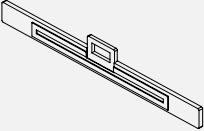
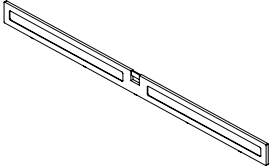
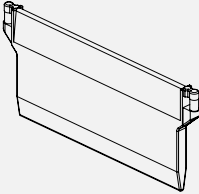
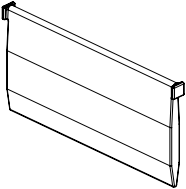
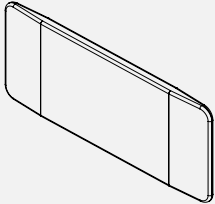
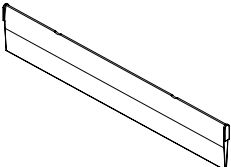
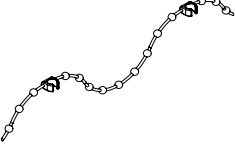
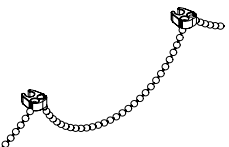
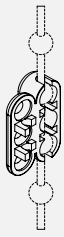
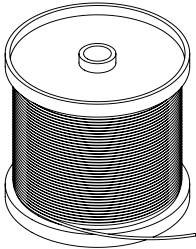
Abbildung Illustration Illustration	Artikelnr. Article No. Code Article	Artikelbezeichnung Designation Designation	Packeinheit Packing Unit Conditionnement
	3.224.505	VERTIKAL-ZUGSCHNUR ø 2,2 mm PULL CORD for vertical blinds ø 2,2 mm CORDON pour stores verticaux ø 2,2 mm	1.000 m 1.000 m 1.000 m
	-001	weiß / white / blanc	
	-010	grau / grey / gris	
	-049	schwarz / black / noir	
	3.235.028	VERTIKAL-ZUGSCHNUR (Enigma) ø 2 mm PULL CORD for vertical blinds ø 2 mm CORDON pour stores verticaux ø 2 mm	1.000 m 1.000 m 1.000 m
	-001	weiß / white / blanc	
-010	grau / grey / gris		
-049	schwarz / black / noir		
	3.230.195	SCHNURBESCHWERER, Aerodesign (230 g) CORD WEIGHT, Aerodesign (230 g) POIDS DE CORDON, Aerodesign (230 g)	40 Stck 40 pcs 40 pcs
	-001	weiß / white / blanc	
	-010	grau / grey / gris	
	3.230.198	SCHNUR- UND KETTENBESCHWERER, (180 g) CORD AND CHAIN WEIGHT, (180 g) POIDS CORDON ET CHAÎNE, (180 g)	50 Stck 50 pcs 50 pcs
	-001	weiß / white / blanc	
	-010	grau / grey / gris	
	-049	schwarz / black / noir	