

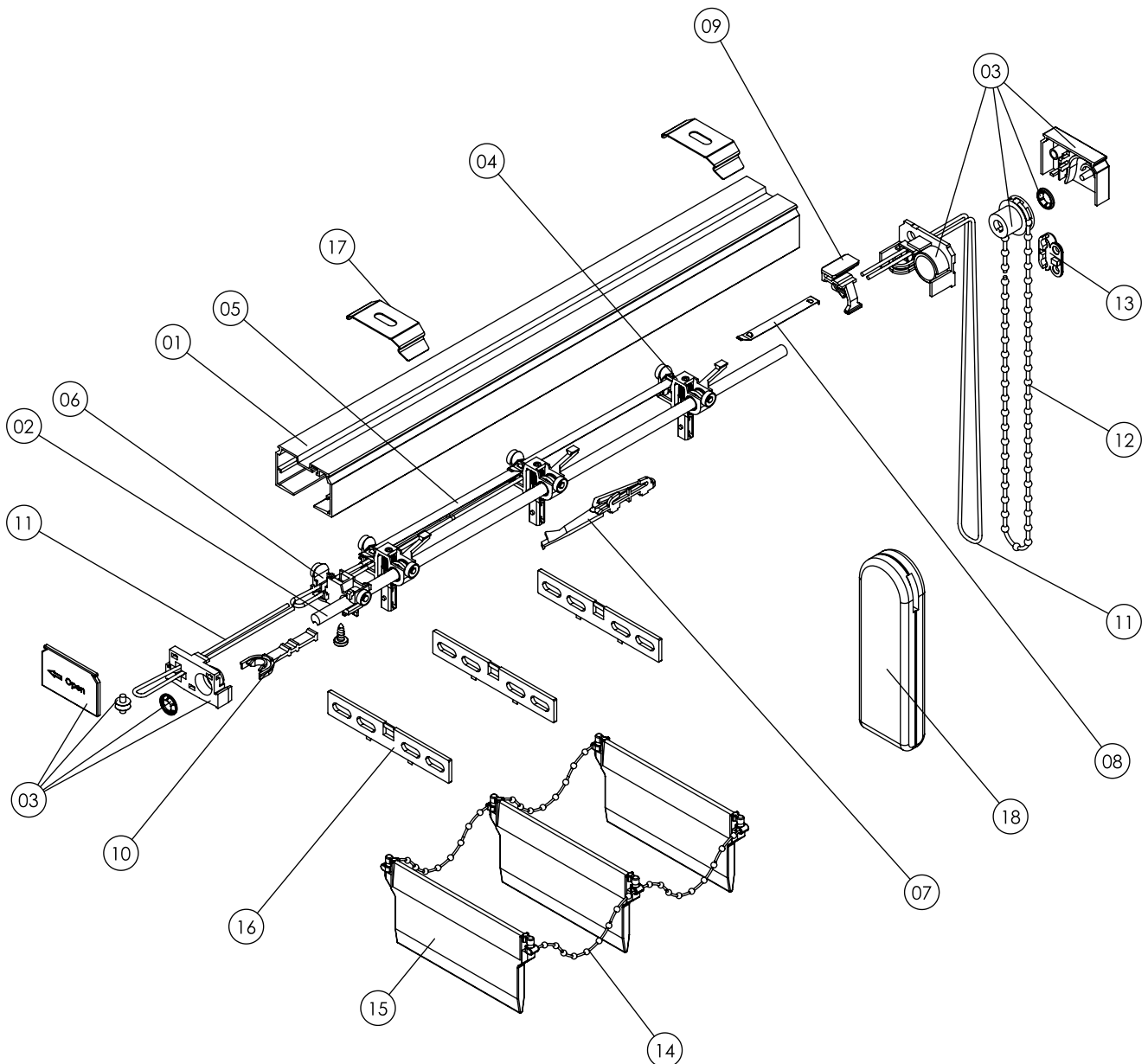

| Nr. No. Code | Artikelnr. Article No. Code Article | Artikelbezeichnung Designation Designation | Nr. No. Code | Artikelnr. Article No. Code Article | Artikelbezeichnung Designation Designation |
|--------------------|---|--|--------------------|---|---|
| 01 | 3.235.001.001 | Laufschiene / Headrail / Boîtier | 11 | 3.235.028.001 | Zugschnur / Pull cord / Cordon |
| 02 | 3.235.005.000 | Nutwelle / Slotted shaft / Axe à rainure | 12 | 3.224.003.001 | Bedienkette / Operating chain / Chainette de commande |
| 03 | 3.235.012.001 | Endkappen-Set / End cap set / Jeu d'Embouts | 13 | 3.232.129.000 | Kettenverbinder / Ball chain connector / Joint de chaîne |
| 04 | 3.235.016.001 | Laufwagen / Runner / Chariot | 14 | 3.233.226.001 | Abstandskette / Bottom chain / Chainette du bas |
| 05 | 3.235.011.xxx | Abstandshalter / Link spacer / Écarteur | 15 | 3.233.225.001 | Beschwerungsplatte / Bottom weight / Plaque de lestage |
| 06 | 3.235.021.001 | Schnurzugwagen / Cord drive runner / Chariot de tirage | 16 | 3.233.221.090 | Lamellenhalter / Slat holder / Support lamelle |
| 07 | 3.235.023.001 | Klappwellenstütze / Shaft support / Support d'arbre | 17 | 3.230.185.001 | Montageclip / Fixing clip / Clip de montage |
| 08 | 3.235.011.030 | Abstandshalter / Link spacer / Ecarteur | 18 | 3.230.174.001 | Schnurbeschwerer / Cord weight / Poids de cordon |
| 09 | 3.235.037.001 | Beweglicher Pakethalter / Moveable bunch-spacer / Porte-paquet mobile | | | |
| 10 | 3.235.027.001 | Auflaufstopper / End retainer / Arrêt fin de boîtier | | | |

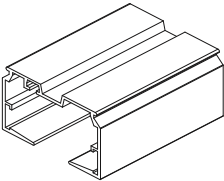

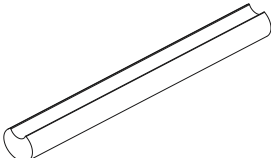
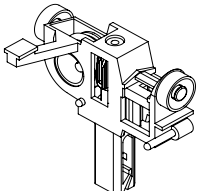
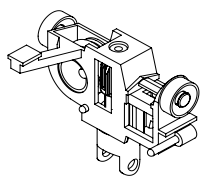

SYSTEM ENIGMA
SYSTEM ENIGMA
SYSTÈME ENIGMA

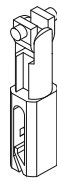
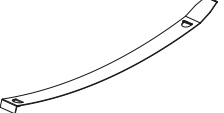
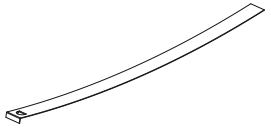
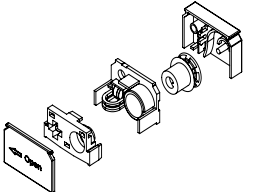
| Abbildung Illustration Illustration | Artikelnr. Article No. Code Article | Artikelbezeichnung Designation Designation | Packeinheit Packing Unit Conditionnement |
|---|---|--|--|
|  | 3.235.001 -001 -049 -058 | ENIGMA-LAUFSCHIENE ENIGMA-HEAD RAIL BOÎTIER ENIGMA weiß / white / blanc schwarz / black / noir eloxiert / anodized / anodisé | 70 m 70 m 70 m Längen à 7 m lengths of 7 m longueurs de 7 m |
|  | 3.235.005.000 | NUTWELLE SLOTTED SHAFT AXE À RAINURE | 70 m 70 m 70 m Längen à 7 m lengths of 7 m longueurs de 7 m |
|  | 3.235.016 -001 -010 | LAUFWAGEN RUNNER CHARIOT weiß / white / blanc grau / grey / gris | 1.134 Stck 1.134 pcs 1.134 pcs |
|  | 3.235.017 -001 -010 | SLOPE-LAUFWAGEN SLOPE RUNNER CHARIOT SLOPE weiß / white / blanc grau / grey / gris | 1.134 Stck 1.134 pcs 1.134 pcs |
|  | 3.235.036 -000 | HAKEN FÜR LAUFWAGEN 3.235.016 XXX HOOK FOR RUNNER 3.235.016 XXX CROCHET POUR CHARIOT 3.235.016 XXX transparent / transparent / transparent | 1.000 Stck 1.000 pcs 1.000 pcs |
|  | 3.235 -018.000 -019.000 -020.000 -034.000 | SLOPE-HAKEN, transparent SLOPE-HOOK, transparent CROCHET SLOPE, transparent kurz, short, court mittel, medium, moyen lang, long, long extra lang, extra long, extra long | 300 Stck 300 pcs 300 pcs |

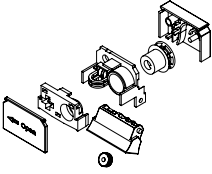
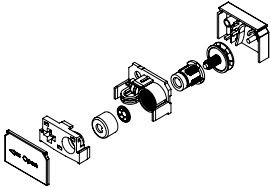
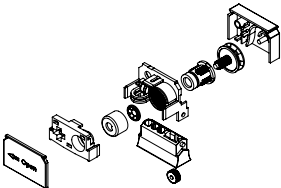
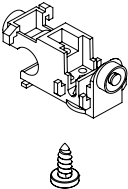
| Abbildung Illustration Illustration | Artikelnr. Article No. Code Article | Artikelbezeichnung Designation Designation | Packeinheit Packing Unit Conditionnement |
|---|---|---|--|
|  | 3.235.011 | ABSTANDSHALTER EDELSTAHL, 0,22 x 6 mm, für Laufwagen 3.235 016, 3.235 017 LINK SPACER FINE STEEL, 0,22 x 6 mm, for runner 3.235 016, 3.235 017 ECARTEUR ACIER INDOX, 0,22 x 6 mm, pour chariot 3.235 016, 3.235 017 | 1.000 Stck 1.000 pcs 1.000 pcs |
| | -030 | 30 mm Länge / length / longueur | |
| | -038 | 38 mm Länge / length / longueur | |
| | -049 | 49 mm Länge / length / longueur | |
| | -071 | 71 mm Länge / length / longueur | |
| | -075 | 75 mm Länge / length / longueur | |
| | -079 | 79 mm Länge / length / longueur | |
| | -083 | 83 mm Länge / length / longueur | |
| | -102 | 102 mm Länge / length / longueur | |
| | -105 | 105 mm Länge / length / longueur | |
| | -108 | 108 mm Länge / length / longueur | |
|  | 3.235.011 | ABSTANDSHALTER EDELSTAHL zum Kürzen, 0,22 x 6 mm, für Laufwagen 3.235 016, 3.235 017 LINK SPACER FINE STEEL for cutting to size, 0,22 x 6 mm, for runner 3.235 016, 3.235 017 ECARTEUR ACIER INDOX à découper, 0,22 x 6 mm, pour chariot 3.235 016, 3.235 017 | 1.000 Stck 1.000 pcs 1.000 pcs |
| | -139 | 139 mm Länge / length / longueur | |
| | -200 | 200 mm Länge / length / longueur | |
|  | 3.235.012 | ENDKAPPEN-SET rechts (1:1) END CAP SET, right (1:1) JEU D'EMBOUITS - droite (1:1) | 100 Satz 100 sets 100 jeux |
| | -001 | weiß / white / blanc | |
| | -010 | grau / grey / gris | |
| | -049 | schwarz / black / noir | |
| | 3.235.013 | ENDKAPPEN-SET links (1:1) END CAP SET, left (1:1) JEU D'EMBOUITS - gauche (1:1) | 100 Satz 100 sets 100 jeux |
| | -001 | weiß / white / blanc | |
| -010 | grau / grey / gris | | |
| -049 | schwarz / black / noir | | |

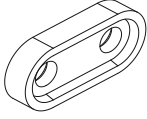
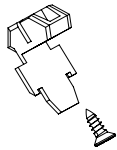
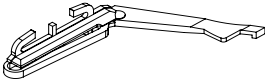
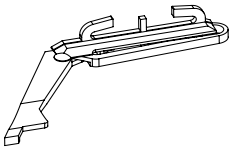
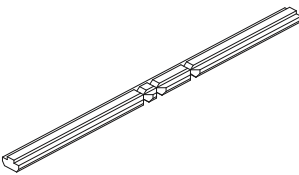
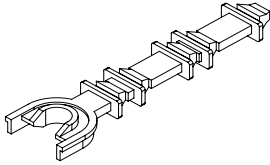
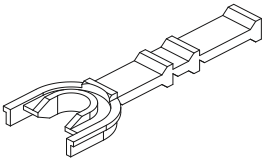
| Abbildung Illustration Illustration | Artikelnr. Article No. Code Article | Artikelbezeichnung Designation Designation | Packeinheit Packing Unit Conditionnement |
|---|---|--|--|
|  | 3.235.014 | SLOPE-ENDKAPPEN-SET rechts (1:1) SLOPE END CAP SET, right (1:1) JEU D'EMBOUTS SLOPE - droite (1:1) | 40 Satz 40 sets 40 jeux |
| | -001 | weiß / white / blanc | |
| | -010 | grau / grey / gris | |
| | -049 | schwarz / black / noir | |
| | 3.235.015 | SLOPE-ENDKAPPEN-SET links (1:1) SLOPE END CAP SET, left (1:1) JEU D'EMBOUTS SLOPE - gauche (1:1) | 40 Satz 40 sets 40 jeux |
| | -001 | weiß / white / blanc | |
| -010 | grau / grey / gris | | |
| -049 | schwarz / black / noir | | |
|  | 3.235.030 | ENDKAPPEN-SET rechts (1:4) END CAP SET, right (1:4) JEU D'EMBOUTS - droite (1:4) | 100 Satz 100 sets 100 jeux |
| | -001 | weiß / white / blanc | |
| | -010 | grau / grey / gris | |
| | 3.235.031 | ENDKAPPEN-SET links (1:4) END CAP SET, left (1:4) JEU D'EMBOUTS - gauche (1:4) | 100 Satz 100 sets 100 jeux |
| | -001 | weiß / white / blanc | |
| | -010 | grau / grey / gris | |
|  | 3.235.032 | SLOPE-ENDKAPPEN - SET rechts (1:4) SLOPE END CAP SET, right (1:4) JEU D'EMBOUTS SLOPE - droite (1:4) | 40 Satz 40 sets 40 jeux |
| | -001 | weiß / white / blanc | |
| | -010 | grau / grey / gris | |
| | 3.235.033 | SLOPE-ENDKAPPEN - SET links (1:4) SLOPE END CAP SET, left (1:4) JEU D'EMBOUTS SLOPE - gauche (1:4) | 40 Satz 40 sets 40 jeux |
| | -001 | weiß / white / blanc | |
| | -010 | grau / grey / gris | |
|  | 3.235.021 | SCHNURZUGWAGEN mit Schraube CORD DRIVE RUNNER with screw CHARIOT DE TIRAGE DU CORDON, avec vis | 500 Satz 500 sets 500 jeux |
| | -001 | weiß / white / blanc | |
| | -010 | grau / grey / gris | |

| Abbildung Illustration Illustration | Artikelnr. Article No. Code Article | Artikelbezeichnung Designation Designation | Packeinheit Packing Unit Conditionnement |
|---|---|--|--|
|  | 3.235.029 -001 -010 | VERBINDUNGSLASCHE für Schnurzugwagen SPLICE PLATE for cord drive runner LANGUETTE DE RACCORDEMENT pour chariot de tirage du cordon weiß / white / blanc grau / grey / gris | 500 Satz 500 sets 500 jeux |
|  | 3.235.022 -001 -010 | LAUFWAGENSTOPPER mit Paketausrastfunktion RUNNER STOP with bunch release function ARRÊT CHARIOT avec fonction du déclenchement du paquet | 150 Satz 150 sets 150 jeux |
|  | 3.235.023 -001 -010 | KLAPPWELLENSTÜTZE rechts HINGED SHAFT SUPPORT, right SUPPORT D'ARBRE, RABATTANT, droite | 200 Stck 200 pcs 200 pcs |
|  | 3.235.024 -001 -010 | KLAPPWELLENSTÜTZE links HINGED SHAFT SUPPORT, left SUPPORT D'ARBRE, RABATTANT, gauche | 200 Stck 200 pcs 200 pcs |
|  | 3.235.025.089 3.235.025.127 | DISTANZHALTER, 89 mm DISTANCE HOLDER, 89 mm ECARTEUR, 89 mm DISTANZHALTER, 127 mm DISTANCE HOLDER, 127 mm ECARTEUR, 127 mm | 600 Stck 600 pcs 600 pcs 600 Stck 600 pcs 600 pcs |
|  | 3.235.026 -001 -010 | PAKETHALTER mit Ausrastfunktion BUNCH HOLDER with release function PORTE PAQUET avec fonction du déclenchement | 150 Stck 150 pcs 150 pcs |
|  | 3.235.027 -001 -010 | AUFLAUFSTOPPER END RETAINER ARRÊT FIN DE BOÎTIER | 150 Stck 150 pcs 150 pcs |

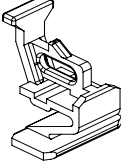
| Abbildung Illustration Illustration | Artikelnr. Article No. Code Article | Artikelbezeichnung Designation Designation | Packeinheit Packing Unit Conditionnement |
|---|---|---|--|
|  | 3.233.215.000 | FÄCHERFEDER RETAINING WASHER BAGUE DE FIXATION | 1.000 Stck 1.000 pcs 1.000 pcs |
|  | 3.235.037 -001 -010 | PAKETHALTER BUNCH-SPACER ARRÊT DE CHARIOT weiß / white / blanc grau / grey / gris | 100 Stck 100 pcs 100 pcs |